

ACKNOWLEDGMENTS

Sciencix is not a distributor of OEM products.

OEM part numbers provided for cross reference purposes only.

ABI™ is a trademark of Kratos International, Inc., a division of PerkinElmer, Inc.

Acquity UPLC® is a registered trademark of Waters Corporation.

Agilent® is a registered trademark of Agilent Technologies, Inc.

Agilent Technologies® is a registered trademark of Agilent Technologies, Inc.

Alliance® is a registered trademark of Waters Corporation.

Beckman® is a registered trademark of Beckman Coulter, Inc.

Delta-Prep™ is a trademark of Waters Corporation.

Gilson® is a registered trademark of Gilson.

Grip-tight™ is a trademark of Chromatography Technology Services Corp.

Jasco® is a registered trademark of Jasco, Inc.

Hitachi® is a registered trademark of Kabushiki Kaisha Hitachi Seisakusho DBA Hitachi, Ltd.

NanoAquity UPLC® is a registered trademark of Waters Corporation.

PEEK™ is a registered trademark of Victrex, PLC.

PerformancePLUS™ is a trademark of Waters Corporation.

PerkinElmer® is a registered trademark of PerkinElmer, Inc.

Rheodyne® is a registered trademark of Rheodyne, LLC.

Shimadzu® is a registered trademark of Shimadzu Corporation.

Spectra-Physics® is a registered trademark of Spectra-Physics, Inc.

Super Seal™ is a trademark of Chromatography Technology Services Corp.

System Gold® is a registered trademark of Beckman Coulter, Inc.

Thermo Separation Products® was previously a registered trademark of Thermo Separation Products, Inc.

TSP® was previously a registered trademark of Thermo Separation Products, Inc.

VespeL® is a registered trademark of Dupont.

Waters® is a registered trademark of Waters Corporation.

WISP® is a trademark of Waters Corporation.



14261 W. Burnsville Parkway
Burnsville, MN 55306

ORDER

952.895.8292

800.682.6480

www.sciencix.com

ISO 9001 : 2008



2016
HPLC Product Catalog



ORDERING INSTRUCTIONS

BY PHONE

Call toll-free 800.682.6480 or 952.895.8292. Our normal business hours are 8 a.m. to 5 p.m. (Central Standard Time). Orders placed after 2 p.m. will be processed the next business day.

BY FAX

Dial 952.895.8493 to send your order by fax, 24 hours a day.

BY E-MAIL

sales@sciencix.com

BY MAIL

Sciencix
P. O. Box 1336
Burnsville, MN 55337-0336

Please provide the following information with your order:

- Purchase order number
- Name of purchaser
- Shipping address
- Billing address
- Telephone number
- Item quantities and part numbers
- Contact person in your accounts payable department

BY EDI

D. I. Central

BY CREDIT CARD

Visa, MasterCard, American Express

BY WEBSITE

www.sciencix.com

TERMS

Various payment options available. Please contact customer service or your sales representative for availability and qualification. No minimum order size requirement.

SHIPPING

All packages are shipped according to customer requests. Our default shipping protocol is UPS ground for domestic packages, and UPS express for international shipments.

WARRANTY

We view your business with us as a partnership based on mutual trust.

Our products are made according to the highest standards as a reflection of our commitment to quality, integrity and in accordance with our ISO certification. Therefore, we are glad to extend a Lifetime Warranty against any manufacturing defects on all Sciencix parts. Sciencix defines the lifetime of a part in accordance with the normal expected performance of the equivalent OEM part. Our intention is to provide replacement parts that are equivalent to or better than the corresponding OEM part. On the rare occasion that you experience a problem with a Sciencix part, we invite you to contact us and share your problem with us. Every attempt will be made to bring resolution in a way that enhances our relationship with you, our valued customer.

Our warranty claim process is simple. Below is a brief outline of how to initiate a warranty claim.

CUSTOMER

Contact Customer Service at 800.682.6480 or 952.895.8292, or contact your Account Manager. Provide as much detail as possible about the part in question, such as part number, lot number, date of purchase, etc. Describe the situation in which the performance of the part was unsatisfactory.

SCIENCIX

We will provide you with a Return Authorization (RA) number and then ship a replacement or credit your account.

SHIP RETURNS TO

Sciencix
14261 W. Burnsville Parkway
Burnsville, MN 55306

Shipment of returned warranty parts to Sciencix is the responsibility of the customer; shipment of replacement parts to the customer's place of business is the responsibility of Sciencix.



CONTENTS

Ordering Instructions	2
Index/Cross-Reference	4-5
Agilent:	6
1260, 1290	6-7
1100, 1200	7-11
1050	12-14
1090	15-16
Beckman	17
Dionex	18
Gilson/Ranin	19
Hitachi/Merck	20
Jasco	21
Rheodyne	21
PerkinElmer, ABI	22-23
Shimadzu	24-27
Thermo Electron and Spectra-Physics	28-30
Waters:	31
M6KA, M45, 501, 510, 515, 590, 600, 610, 1515, 1525, LC MODULE 1, PREP LC-4000	31-36
616, 625, 626, 1515 MICRO	37
717, 2690, 2690D, 2695, 2695D, 2790, 2795, 2796	38-43
ACQUITY, nanoACQUITY, H-CLASS, I-CLASS	44-49
470, 474, 484, 486, 996, 2487, 2488, 2996	50
Lamps	51-53
Tools	54
Filters, Fittings & Tubing:	55
Filters	55
Fittings	56
Tubing	57-58
Pump Troubleshooting Procedures	59
Acknowledgments	60

OUR PROCESS

MATERIALS. GEOMETRY. PERFORMANCE. APPEARANCE.

Understanding the requirements of our customers and the analytical instrumentation industry is at the core of our process for solid product design. It all starts with listening. With years of experience and discussions with a variety of customers, we have distilled what we've learned into the four pillars of our product design process: materials, geometry, performance, and appearance.

Our intent is to provide CTS replacement parts that are, in each case, "equivalent to" or better than the corresponding OEM part.

With the product process in mind, Sciencix pursues two possible paths towards offering OEM alternative parts. Sciencix has cultivated relationships with many parts and component manufacturing companies that cater to high tech industries such as analytical instrumentation. Sciencix uses these vendors wherever possible to source parts that match the performance and look of the OEM's. Alternatively, we develop the products in-house. This process includes reverse engineering dimensions and materials, prototyping, and testing.

Our desired outcome from this rigorous process is to provide you with the analytical instrumentation parts and services you need, when you need them — all supplied by friendly, knowledgeable people at a reasonable price. We want you to be completely satisfied with every aspect of your dealings with Sciencix, from order placement through product delivery and performance. Please help us in our pursuit. Let us know of any issues you have had with any order from Sciencix. We will work with you to try and get it satisfactorily resolved whether through warranty claims, product replacement or process improvement.

That is our process and guarantee to you.



INDEX / CROSS-REFERENCE

OEM p/n	CTS p/n	Page	OEM p/n	CTS p/n	Page	OEM p/n	CTS p/n	Page
AGILENT			BECKMAN			PERKINELMER/ABI		
—	CTS-10800	8, 13	237162	CTS-7162	17	7725-026	CTS-A11329	23
—	CTS-11332-1	13	238627	CTS-10391	17	02540275	CTS-10757	22
—	CTS-10723	14	240619	CTS-A033	17	02540177	CTS-A159	22
0100-1851	CTS-A10678	10	240620	CTS-0621	17	02540197	CTS-A157	22
0100-1852	CTS-11288	11	240621	CTS-0620	17	02542076	CTS-10759	22
0100-1853	CTS-10459	10	240714	CTS-2369	17	09902128	CTS-00230-02	22
0100-1855	CTS-11419	11	240720	CTS-0720	17	09904802	CTS-A019	23
0100-1859	CTS-A11329	11	240721	CTS-0721	17	09907324	CTS-10758	22
0101-0623	CTS-A019	11	728770	CTS-7162	17	09907339	CTS-10772	22
0101-0626	CTS-10458	14	728770	CTS-10557	17	09923270	CTS-A168	23
01018-22707	CTS-10683	8, 12	243053	CTS-2430	17	B0114620	11-3343	23,52
01018-60010	CTS-11332	13	728772	CTS-10391	17	B0160917	CTS-10854	23,52
01018-60025	CTS-A11259	8, 12, 15	887138	CTS-8871	17	ED020005	11-1240	22
01078-67200	CTS-10677	14	DIONEX			L6022728	CTS-10854	52
01078-87303	CTS-10725	14	063382	11-2587	18	N2600104	CTS-11367	22
08452-60104	CTS-00128	16, 51	064946	11-2588	18	N2600124	CTS-11366	22
0905-1175	CTS-10675	7, 12	6805.1334	11-2642	18	N2910383	CTS-11265	22
0905-1420	CTS-11088	6, 7, 12	6810.3002	11-2643	18	N2920149	CTS-00025	23,52
1535-4048	CTS-A083	16	5805.2930	11-3322	18	N2930023	CTS-10724	23
2140-0590	CTS-10473	11, 51	6822.0002	11-3332	18	RHEODYNE		
2140-0605	CTS-10594	16, 51	—	CTS-00246	52	7010-015	CTS-10612	21
2140-0813	CTS-A11218	7, 11, 51	GILSON/RAININ			7010-039	CTS-A083	21
3980-0672	CTS-10273	15	3650009	CTS-11368	19	7125-047	CTS-A019	21
5021-1816	CTS-11456	6, 9	3650170	CTS-A11206	19	7725-026	CTS-A11329	21
5021-1817	CTS-11457	6, 9	3650180	CTS-A11211	19	SHIMADZU		
5021-1818	CTS-11458	6, 9	5463050825	CTS-11014-01	19	228-09054-93	CTS-A100	25
5021-1819	CTS-11459	6, 9	5463125095	CTS-10889-02	19	228-11200-91	CTS-10595	25
5041-2168	CTS-10843	6, 8, 12, 15	5463125895	CTS-10889-01	19	228-11999-00	CTS-0422	24
5062-2418	CTS-11016	8, 13, 15	R007101636	CTS-10889-02	19	228-12353-91	CTS-A099	25
5062-2484	11-3321	7, 12	R007101637	CTS-10889-01	19	228-17019-93	CTS-10319	24
5062-2494	CTS-10416	15	R007101643	CTS-11014-01	19	228-18523-91	CTS-10320	24
5062-8562	CTS-10673	8, 12	HITACHI/MERCK			228-21217-91	CTS-A106	27
5063-6505	CTS-10807	8, 12	655-1080	CTS-10394	20	228-21217-97	CTS-10942	27
5063-6586	CTS-10303	6, 7, 12	655-1080	CTS-10547	20	228-21220-91	CTS-A067	27
5063-6589	CTS-10417	6, 7, 12	810-1004	CTS-A125	20	228-21975-00	CTS-10340	24
5063-6591	11-1240	8, 13	810-1005	CTS-A126	20	228-25237-04	CTS-10578	27
5065-4498	CTS-11287	10	810-1033	CTS-10322	20	228-28499-00	CTS-10583	25
5065-4499	CTS-11284	8, 13	810-3095	CTS-A124	20	228-32166-91	CTS-A117	25
5067-4728	CTS-A11454	6, 7, 12	885-1330	CTS-A084	20	228-32531-92	CTS-A103	25
5068-0007	CTS-11-2312	7	885-1331	CTS-A085	20	228-32628-00	CTS-10963	25
5181-1530	CTS-10827	11, 51	AN0-0818	CTS-10573	20	228-32784-91	11-2891	25
79835-67101	CTS-10272	15	AN0-0833	CTS-A084	20	228-3335-01	CTS-11435	27
79846-67101	CTS-A160	14, 16	AN0-0834	CTS-A085	20	228-33355-04	CTS-10686	27
79853-60002	CTS-00129	14, 51	AN0-0835	CTS-10493	20	228-33492-91	CTS-A102	25
79883-60002	CTS-00127	14, 51	AN0-0836	CTS-A125	20	228-34016-02	CTS-00135	27,52
G1310-68730	CTS-11286	9	AN0-0837	CTS-A126	20	228-34976-91	CTS-A121	25
G1310-68731	CTS-10814	8, 13	AN0-2328	CTS-10322	20	228-35009-92	CTS-10584	24
G1311-60012	CTS-10674	8, 12	JASCO			228-35009-93	CTS-11425	24
G1311-68710	CTS-10833	9, 13	2305-0005A	CTS-10955	21	228-35010-91	CTS-11434	27
G1312-60012	CTS-A162	8	6560-404A	CTS-10972	21	228-35145-00	CTS-10694	24,27
G1312-68730	CTS-11285	9	6560-405A	CTS-10971	21	228-35146-00	CTS-10693	24
G1312-87303	CTS-A11459	6, 9	6560-H148-PE	CTS-11027	21	228-35281-95	11-3795	24
G1312-87306	CTS-A11456	6, 9	6778-H109A	CTS-10971	21	228-35601-91	CTS-A138	24
G1313-68709	CTS-10722	10	6778-H110A	CTS-10972	21	228-35601-93	CTS-11297	24
G1313-68730	CTS-11283	10	ABI/KRATOS			228-35602-91	11-3897	24
G1313-87201	CTS-10835	7, 10	N2920149	CTS-00025	52	228-35871-96	CTS-A11421	26
G1313-87202	CTS-11356	11				228-36923-00	CTS-11313	27
G1314-60100	CTS-10494	11, 51				228-39093-92	CTS-A145	25
G1329-87017	11-2605	7, 10				228-41310-92	CTS-11312	27
						228-42325-01	CTS-11315	27
						228-45704-92	11-3807	26
						228-45705-91	CTS-A11187	26
						228-45707-91	CTS-A11316	25
						228-48249-91	CTS-A11186	26
						228-48607-91	CTS-11305	26

INDEX / CROSS-REFERENCE

OEM p/n	CTS p/n	Page	OEM p/n	CTS p/n	Page	OEM p/n	CTS p/n	Page
SPECTRA-PHYSICS								
9551-0023	CTS-00246	29, 52	700002599	CTS-11119-02	44	WAT026809	CTS-6809	34,39
THERMO ELECTRON AND SPECTRA-PHYSICS								
108052	CTS-A123	29, 52	700002600	CTS-11093-02	44	WAT030547	CTS-10323	37
801306	CTS-7000	28	700002632	CTS-11116	47	WAT031788	CTS-10323	37
900946	CTS-A091	28	700002633	CTS-11115	47	WAT031790	CTS-11032	37
2508-0360	CTS-A083	29	700002634	11-2525	48	WAT033325	CTS-A136	31
3301-0100	CTS-10517	29	700002635	11-2526	48	WAT033326	CTS-3326	31
7010-015	CTS-10612	29	—	11-2610	34,39	WAT033679	CTS-0100	31
00107-18008	11-1601	30	—	11-2611	34,39	WAT034515	CTS-10906	37
00950-30004	11-1602	30	—	11-2612	34,39	WAT035190	CTS-10527	39
00950-30009	11-1604	30	700002644	CTS-A11151	49	WAT045407	CTS-10285	41
00950-30020	11-1597	29	700002645	11-2529	48	WAT045424	CTS-10761	42
00950-30021	11-1599	29	700002791	CTS-11222	42	WAT045454	CTS-10692	42
00950-30025	11-1603	30	700002911	CTS-A11135	46	WAT045559	CTS-10324S	43
00950-30026	11-1598	29	700002912	CTS-A11123-02	47	WAT052586	CTS-10268	50,53
00950-01-00085	11-1600	29	700002913	CTS-11415	46	WAT052587	CTS-11010	36
00950-01-00087	11-1596	29	700002968	CTS-A11095-02	46	WAT052666	CTS-11065	50
00950-01-00086	11-3943	29	700003114	11-2414	47	WAT052669	CTS-10987	43
9551-0023	CTS-00246	29,52	700003563	CTS-A11336-02	46	WAT052670	CTS-11009	36
206129001	CTS-20612	28	700003616	CTS-5531-07	44	WAT052672	CTS-10986	37
206156001	CTS-2061	28	700004073	CTS-11080	40	WAT052673	CTS-11026	37
801892001	CTS-A079	28	700005119	CTS-A11376	46	WAT052675	CTS-10985	36
A2962-010	CTS-2962	28	700005164	CTS-A11095	46	WAT060012	CTS-0012	35
A2963-010	CTS-2963	28	700005165	CTS-A11336	46	WAT060037	CTS-0037	33
A3102-010	CTS-3102	28	700005173	CTS-A11344	46	WAT060038	CTS-0038	33
A3490-010	CTS-3490	28	700005167	CTS-11370	47	WAT060058	CTS-0058	35
A3495-010	CTS-3495	28	—	CTS-A142	31	WAT060069	CTS-0069L	33
A3588-020	CTS-A096	29	—	CTS-0068	35	WAT060069	CTS-0069R	33
A3990-010	CTS-3990	28	—	CTS-1068	36	WAT060304	CTS-6030	33
A4848-010	CTS-10396	28	—	CTS-8389	50,53	WAT060307	CTS-0307	32
			WAS207069	CTS-10475	33	WAT060448	CTS-9600	35
			—	CTS-10475-1	33	WAT060476	CTS-5740	34
			—	CTS-10548	32	WAT060495	CTS-0110	31
			—	CTS-10611	50,53	WAT069511	CTS-5656	33
			—	CTS-11030	41	WAT069583	CTS-6958	34
			—	CTS-11380	40	WAT072324	CTS-2324	41
WATERS			WAS081142	CTS-10465	50,53	WAT073109	CTS-3109	41
201000113	CTS-11294	36	WAS081341	CTS-A11184	50	WAT073195	CTS-3195	40
201000114	CTS-11282	36	WAS207069	CTS-10475	33	WAT076152	CTS-11092	46
201000173	CTS-11091	44	WAT005081	CTS-5669	33	WAT077347	CTS-3209	41
201000197	CTS-11371	44	WAT005139	CTS-10919-5	38,43	WAT078800	CTS-10285	41
201000233	CTS-11335	45	WAT007272	CTS-10984	38	WAT080244	CTS-10328	50
205000362	CTS-A11381	49	WAT010106	CTS-1106	35	WAT080335	CTS-0335	50
289003547	CTS-A11123	47	WAT011042	CTS-1042	33,54	WAT080336	CTS-0336	50
401000501	CTS-11150	49	WAT022330	CTS-2330	34,39	WAT080443	CTS-10945	39
405008854	11-2591	49	WAT022934	CTS-2294	32	WAT080687	CTS-8068	50
405011492	11-2570	49	WAT022946	CTS-2294-04	32	WAT084561	CTS-10527	39
401000694	11-3606	49	WAT024120	CTS-A058	37	WAT088084	CTS-10919	38,43
430001084	CTS-A11142	49	WAT024960	CTS-A057	37	WAT088223	CTS-8223	31
430001121	CTS-A11133	47	WAT025028	CTS-0200	31	WAT088726	CTS-11296	37
430001326	CTS-A11147	49	WAT025203	CTS-0106	31	WAT097332	CTS-9733	34,39
430001443	CTS-A11374	46	WAT025207	CTS-0301	32	WAT097387	CTS-1010T	42
430001470	CTS-A11129	47	WAT025212	CTS-0201	31	WAT270488	CTS-10476	38
430001486	CTS-A11145	47	WAT025216	CTS-0300	32	WAT270938	CTS-10566	38
430001773	CTS-A11372	46	WAT025313	CTS-5313	34,39	WAT270939	CTS-10989	38
430002357	CTS-A11342	47	WAT025464	CTS-5464	33	WAT270940	CTS-10597	38
430002452	11-3602	49	WAT025531	CTS-5531	37,39	WAT270941	CTS-A094	39
700000254	CTS-10600	31,38	WAT025559	CTS-5559	34	WAT270942	CTS-11029	42
700000356	CTS-10699	50,53	WAT025656	CTS-5656	33	WAT270944	CTS-10988	40
700001229	CTS-10770	41	WAT025669	CTS-5669	33	WAT270959	CTS-10476	38
700001247	CTS-7550	42	WAT025746	CTS-5746	35	WAT271017	CTS-10532	38
700001318	CTS-10788-5	42	WAT025893	CTS-A087	41	WAT271018	CTS-10560	38
700002332	CTS-A11431-02	39	WAT026014	CTS-0310	32	WAT271019	CTS-10839	42
700002399	11-2401	31,38	WAT026016	CTS-0210	31	WAT271066	CTS-10711	38
700002569	11-3595	49	WAT026613	CTS-6613	32	WAT271067	CTS-10476	38
700002570	CTS-A11167	49	WAT026644	CTS-10832	33			
700002572	CTS-11149	49	WAT026644	CTS-6644	32			
700002596	CTS-A11094-02	46						
700002598	CTS-11121-02	44						

PUMP PARTS

MODEL: 1260, 1290



MODEL: 1260, 1050,
1100, 1200, 1220

CTS-10303
OEM 5063-6586

Sapphire Plunger



MODEL: 1260, 1100, 1200

CTS-11457
OEM 5021-1817

**Capillary, 150mm x
0.17mm ID**



MODEL: 1260, 1050,
1100, 1200, 1220

CTS-10417
OEM 5063-6589

Black Piston Seals, 2/pk



MODEL: 1260, 1100, 1200

CTS-11458
OEM 5021-1818

**Capillary, 280mm x
0.17mm ID**



MODEL: 1260, 1050,
1100, 1200, 1220

CTS-11088
OEM 0905-1420

Gold Piston Seals, 2/pk



MODEL: 1260, 1100, 1200

CTS-11459
OEM 5021-1819

**Capillary, 400mm x
0.17mm ID**



MODEL: 1260, 1050,
1100, 1200, 1220

CTS-A11454
OEM 5067-4728

Seal Cap Assembly



MODEL: 1260, 1100,
1200, G1312

CTS-A11456
OEM G1312-87306

**Assy, Capillary, 105mm x
0.17mm ID, w/Fittings**



MODEL: 1260, 1290, 1050,
1090, 1100, 1200, 1220

CTS-10843
OEM 5041-2168

Glass Solvent Filter



MODEL: 1260, 1100,
1200, G1312

CTS-A11459
OEM G1312-87303

**Assy, Capillary, 400mm x
0.17mm ID, w/Fittings**



MODEL: 1260, 1100, 1200

CTS-11456
OEM 5021-1816

**Capillary, 105mm x
0.17mm ID**

AUTOSAMPLER

MODEL: 1260, 1290



MODEL: 1260, 1100,
1200, 1220

CTS-10835
OEM G1313-87201

Needle Assembly

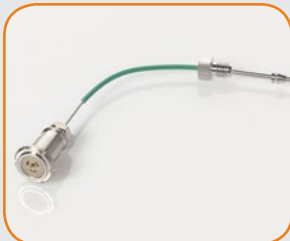

MODEL: 1260, 1100, 1200,
1220, G1313A, G1329A/B

11-2605
OEM G1329-87017

**Needle Seat, Std.,
PEEK™, 0.17mm ID**



MODEL: 1290

11-2312
OEM 5068-0007

**2 Position/6 Port
Rotor Seal (1200 bar)**

DETECTOR LAMPS

MODEL: 1260



MODEL: 1260, 1100, 1200,
1220, G1315A/B, G1365A/B

CTS-A11218
OEM 2140-0813

**Long Life Deuterium Lamp
(2000 hr)**

PUMP PARTS

MODEL: 1100, 1200



MODEL: 1100, 1200,
1220, 1260, 1050

CTS-10303
OEM 5063-6586

Sapphire Plunger



MODEL: 1100, 1200,
1220, 1260, 1050

CTS-10417
OEM 5063-6589

Black Piston Seals, 2/pk



MODEL: 1100, 1200,
1220, 1260, 1050

CTS-11088
OEM 0905-1420

Gold Piston Seals, 2/pk



MODEL: 1100, 1200,
1220, 1260, 1050

CTS-A11454
OEM 5067-4728

Seal Cap Assembly



MODEL: 1100,
1200, 1050

CTS-10675
OEM 0905-1175

Wash Seal



MODEL: 1100,
1200, 1050

11-3321
OEM 5062-2484

Wash Seal Gasket, 6/pk

PUMP PARTS

MODEL: 1100, 1200



MODEL: 1100, 1200, 1050, G1310A, G1311A, G1312A/C, G1322A, G1376A, COMPATIBLE TO G1311C, INFINITY AND 1260 INFINITY CAP/NANO PUMPS

CTS-10673
OEM 5062-8562
Active Inlet Valve Cartridge (400 bar)



MODEL: 1100, 1200
CTS-A162
OEM G1312-60012
Outlet Ball Valve, (400 bar) Binary Pump



MODEL: 1100, 1200, 1050
CTS-10674
OEM G1311-60012
Outlet Ball Valve



MODEL: 1100, 1200
CTS-10807
OEM 5063-6505
Outlet Valve Sieves, 10/pk



MODEL: 1100, 1200, 1050
CTS-10683
OEM 01018-22707
PTFE Frits, 5/pk



MODEL: 1100, 1200, 1220, 1260, 1290, 1050, 1090
CTS-10843
OEM 5041-2168
Glass Solvent Filter



MODEL: 1100, 1200, 1050, 1090
CTS-A11259
OEM 01018-60025
Solvent Inlet Filter, SS



MODEL: 1100, 1200, 1220, 1050, 1090
11-1240
OEM 5063-6591
Nut, PEEK™ Fingertight 1/16", 10/pk



MODEL: 1100, 1200, 1050
CTS-10800 KIT
Seal Wash Kit, Binary Pump

- Seals (CTS-10675) 4
- Gaskets (CTS-10812) 4



MODEL: 1100, 1200, 1050
CTS-10814 KIT
OEM G1310-68731
Seal Wash Kit

- Seals (CTS-10675) 2
- Gaskets (CTS-10812) 2



MODEL: 1100, 1200, 1050, 1090
CTS-11016 KIT
OEM 5062-2418
Swagelok® Style Compression Fitting Kit, 10/pk

- Nut 10
- Front Ferrule 10
- Back Ferrule 10



MODEL: 1100, 1200
CTS-11284 KIT
OEM 5065-4499
Extended Isocratic Pump PM Kit

- Sapphire Plunger (CTS-10303) 2
- Black Piston Seals, 2/pk (CTS-10417) 1
- Active Inlet Cartridge (CTS-10673) 1
- Outlet Ball Valve (CTS-10674) 1
- Frit, PTFE, 5/pk (CTS-10683) 1

PUMP PARTS

MODEL: 1100, 1200



MODEL: 1100, 1200

CTS-11285 KIT

OEM G1312-68730

Binary Pump PM Kit

- Black Piston Seals, 2/pk (CTS-10417) 2
- Seal Cap Assembly (CTS-A11454) 3
- PTFE Frits (CTS-10712) 2
- Screen Filter (CTS-10781) 2



MODEL: 1100, 1200

CTS-11286 KIT

OEM G1310-68730

**PM Kit for Isocratic/
Quarternary Pump**

- Black Piston Seals, 2/pk (CTS-10417) 1
- PTFE Frits (CTS-10712) 2
- Seal Cap Assembly (CTS-A11454) 2



MODEL: 1100, 1200, 1050

CTS-10833 KIT

OEM G1311-68710

Pump Maintenance Kit

- Black Piston Seals, 2/pk (CTS-10417) 2
- Active Inlet Cartridge (CTS-10673) 1
- PTFE Frits (CTS-10712) 2
- Glass Solvent Filter (CTS-10843) 2
- Seal Cap Assembly (CTS-A11454) 1



MODEL: 1100, 1200, 1260

CTS-11456

OEM 5021-1816

**Capillary, 105mm x
0.17mm ID**



MODEL: 1100, 1200, 1260

CTS-11457

OEM 5021-1817

**Capillary, 150mm x
0.17mm ID**



MODEL: 1100, 1200, 1260

CTS-11458

OEM 5021-1818

**Capillary, 280mm x
0.17mm ID**



MODEL: 1100, 1200, 1260

CTS-11459

OEM 5021-1819

**Capillary, 400mm x
0.17mm ID**



MODEL: 1100, 1200,
1260, G1312

CTS-A11456

OEM G1312-87306

**Assy, Capillary, 105mm x
0.17mm ID, w/Fittings**



MODEL: 1100, 1200,
1260, G1312

CTS-A11459

OEM G1312-87303

**Assy, Capillary, 400mm x
0.17mm ID, w/Fittings**

AUTOSAMPLER

MODEL: 1100, 1200



MODEL: 1100, 1200, G1313, G1327A

CTS-10722 **KIT**

OEM G1313-68709

Autosampler Preventative Maintenance Kit

- Rotor Seal Assy (CTS-10459) 1
- Black Piston Seals, 2/pk (CTS-10417) 1
- Needle Assembly (CTS-10835) 1
- Needle Seat, Std., PEEK™, 0.17mm ID (11-2605) 1
- Finger Caps, 3/pk (CTS-10834) 1



MODEL: 1100, 1200, G1313, G1327A

CTS-11287 **KIT**

OEM 5065-4498

Extended PM Kit for Standard Autosamplers

- Isolation Seal (CTS-11288) 1
- Rotor Seal Assy (CTS-10459) 1
- Stator Face Assy (CTS-A10678) 1
- Needle Assembly (CTS-10835) 1
- Needle Seat, Std., PEEK™, 0.17mm ID (11-2605) 1

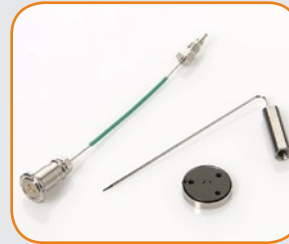

MODEL: 1100, 1200, G1313, G1327A, G1329A

CTS-11283 **KIT**

OEM G1313-68730

PM Kit for Standard Autosamplers

- Rotor Seal Assy (CTS-10459) 1
- Needle Assembly (CTS-10835) 1
- Needle Seat, Std., PEEK™, 0.17mm ID (11-2605) 1



MODEL: 1100, 1200, 1220, 1260

CTS-10835

OEM G1313-87201

Needle Assembly



MODEL: 1100, 1200, 1220, 1260, G1313A, G1329A/B

11-2605

OEM G1329-87017

Needle Seat, Std., PEEK™, 0.17mm ID



MODEL: 1100, 1200

CTS-10459

OEM 0100-1853

Rotor Seal, Vespel®, 2-Groove, 7750-020

AUTOSAMPLER

MODEL: 1100, 1200



MODEL: 1100, 1200
CTS-11419
 OEM 0100-1855
Rotor Seal, Vespel®
 for p/n 0101-0921



MODEL: 1100, 1200
CTS-A10678
 OEM 0100-1851
Stator Face Assembly
 for 0101-0921 Valve



MODEL: 1100, 1200
CTS-11288
 OEM 0100-1852
Isolation Seal for
 0101-0921 Valve



MODEL: 1100, 1200
CTS-11356
 OEM G1313-87202
Needle, 900µL



MODEL: 1100, 1200
CTS-A019
 OEM 0101-0623
Manual Injection Valve
 Rotor Seal, Vespel®



MODEL: 1100, 1200
CTS-A11329
 OEM 0100-1859
Stator Face Assembly for
 5063-6502 Valve

DETECTOR LAMPS

MODEL: 1100, 1200



MODEL: 1100, 1200 DAD,
 G1315A/B, G1365A/B
CTS-10473
 OEM 2140-0590
Deuterium Lamp (1000 hr)



MODEL: 1100, 1200 VWD,
 1220 VWD, G1314A/B
CTS-10494
 OEM G1314-60100
Long Life Deuterium Lamp
 (2000 hr)



MODEL: 1100, 1200 DAD,
 G1315A/B, G1365A/B
CTS-10827
 OEM 5181-1530
Long Life Deuterium Lamp
 (2000 hr)



MODEL: 1100, 1200, 1220,
 1260, G1315A/B, G1365A/B
CTS-A11218
 OEM 2140-0813
Long Life Deuterium Lamp
 (2000 hr)

PUMP PARTS

MODEL: 1050



MODEL: 1050, 1100,
1200, 1220, 1260

CTS-10303
OEM 5063-6586

Sapphire Plunger



MODEL: 1050, 1100,
1200, 1220, 1260

CTS-10417
OEM 5063-6589

Black Piston Seals, 2/pk



MODEL: 1050, 1100,
1200, 1220, 1260

CTS-11088
OEM 0905-1420

Gold Piston Seals, 2/pk



MODEL: 1050, 1100,
1200, 1220, 1260

CTS-A11454
OEM 5067-4728

Seal Cap Assembly



MODEL: 1050,
1100, 1200

CTS-10673
OEM 5062-8562

**Active Inlet Cartridge Valve
(400 bar)**



MODEL: 1050,
1100, 1200

CTS-10674
OEM G1311-60012

Outlet Ball Valve

MODEL: 1050



MODEL: 1050,
1100, 1200

CTS-10675
OEM 0905-1175

Wash Seal



MODEL: 1050,
1100, 1200

11-3321
OEM 5062-2484

Wash Seal Gasket, 6/pk



MODEL: 1050,
1100, 1200

CTS-10683
OEM 01018-22707

PTFE Frits, 5/pk



MODEL: 1050, 1100, 1200

CTS-10807
OEM 5063-6505

Outlet Valve Sieves, 10/pk



MODEL: 1050, 1090, 1100,
1200, 1220, 1260, 1290

CTS-10843
OEM 5041-2168

Glass Solvent Filter



MODEL: 1050,
1090, 1100, 1200

CTS-A11259
OEM 01018-60025

Solvent Inlet Filter, SS

PUMP PARTS

MODEL: 1050



MODEL: 1050, 1100, 1200

CTS-10800 KIT

Seal Wash Kit, Binary Pump, 4/pk

- Seals (CTS-10675) 4
- Gaskets (CTS-10812) 4



MODEL: 1050, 1100, 1200

CTS-10814 KIT

OEM G1310-68731

Seal Wash Kit, 2/pk

- Seals (CTS-10675) 2
- Gaskets (CTS-10812) 2



MODEL: 1050, 1090, 1100, 1200

CTS-11016 KIT

OEM 5062-2418

Swagelok® Style Compression Fitting Kit, 10/pk

- Nut 10
- Front Ferrule 10
- Back Ferrule 10



MODEL: 1050, 1100, 1200

CTS-11284 KIT

OEM 5065-4499

Extended Isocratic Pump PM Kit

- Sapphire Plunger (CTS-10303) 2
- Black Piston Seals, 2/pk (CTS-10417) 1
- Active Inlet Cartridge (CTS-10673) 1
- Outlet Ball Valve (CTS-10674) 1
- Frit, PTFE, 5/pk (CTS-10683) 1



MODEL: 1050, 1090, 1100, 1200, 1220

11-1240
OEM 5063-6591

Nut, PEEK™ Fingertight 1/16", 10/pk



MODEL: 1050

CTS-11332-1

1050 Active Inlet Valve (Replacement for use in CTS-11332)



MODEL: 1050

CTS-11332 KIT

OEM 01018-60010

1050 Active Inlet Valve Upgrade Kit



MODEL: 1050, 1100, 1200

CTS-10833 KIT

OEM G1311-68710

Pump Maintenance Kit

- Black Piston Seals, 2/pk (CTS-10417) 2
- Active Inlet Cartridge (CTS-10673) 1
- PTFE Frits (CTS-10712) 2
- Glass Solvent Filter (CTS-10843) 2
- Seal Cap Assembly (CTS-A11454) 1

AUTOSAMPLER

MODEL: 1050



MODEL: 1050
CTS-10677
OEM 01078-67200
Needle Assembly



MODEL: 1050
CTS-10725
OEM 01078-87303
Seat Capillary



MODEL: 1050, 1090
CTS-A160
OEM 79846-67101
Needle Seat



MODEL: 1050
CTS-10458
OEM 0101-0626
Rotor Seal, Vespel®, 2-Groove

DETECTOR LAMPS



MODEL: 1090, 1040, 1050
CTS-00127
OEM 79883-60002
VW (79583C), DAD (G1306A), MWD (79854A) (1000 hr)



MODEL: 1050, 79853A
CTS-00129
OEM 79853-60002
1050 VW Lamp (1000 hr)



MODEL: 1050

CTS-10723 KIT
Autosampler Preventative Maintenance Kit

- Rotor Seal (CTS-10458) 1
- Needle (CTS-10677) 1
- Needle Seat (CTS-A160) 1
- Seat Capillary (CTS-10725) 1

PUMP PARTS

MODEL: 1090



MODEL: 1090
CTS-10273
 OEM 3980-0672
Sapphire Plunger



MODEL: 1090, 1050,
 1100, 1200, 1220,
 1260, 1290
CTS-10843
 OEM 5041-2168
Glass Solvent Filter



MODEL: 1090
CTS-10416
 OEM 5062-2494
Plunger Seals, Black, 4/pk



MODEL: 1090, 1050,
 1100, 1200
CTS-A11259
 OEM 01018-60025
Solvent Inlet Filter, SS



MODEL: 1090
CTS-10272
 OEM 79835-67101
**Check Valve
 Cartridge Assembly**



MODEL: 1090, 1050, 1100, 1200

CTS-11016 KIT
 OEM 5062-2418

**Swagelok® Style Compression
 Fitting Kit, 10/pk**

- Nut 10
- Front Ferrule 10
- Back Ferrule 10

AUTOSAMPLER & DETECTOR LAMP

MODEL: 1090



MODEL: 1090, 1050

CTS-A160
OEM 79846-67101
Needle Seat



MODEL: 1090

CTS-A083
OEM 1535-4048
Rotor Seal, Rheodyne
7010, 7000, 7040



MODEL: 1090, 1050

CTS-00127
OEM 79883-60002
VW (79583C),
DAD (G1306A),
MWD (79854A)
(1000 hr)

SPECTROPHOTOMETER LAMPS

MODEL: 8452A, 8453, 8454



MODEL: 8452A

CTS-00128
OEM 08452-60104
Long Life Deuterium Lamp
(2000 hr)



MODEL: 8453, 8454

CTS-10594
OEM 2140-0605
Deuterium Lamp (1000 hr)

PUMP PARTS



MODEL: 100A, 110A,
110B, 112, 114M, 116,
118, 125, 126, 127, 128

CTS-0620
OEM 240621
**Outlet Check
Valve Cartridge**



MODEL: 100A, 110A,
110B, 112, 114M, 116,
118, 125, 126, 127, 128

CTS-0621
OEM 240620
**Inlet Check
Valve Cartridge**



MODEL: 100A, 110A,
110B, 112, 114M, 116,
118, 125, 126, 127, 128

CTS-0721
OEM 240721
**Outlet Check
Valve Assembly**



MODEL: 110A, 110B,
112, 114M, 116, 118,
125, 126, 127, 128

CTS-0720
OEM 240720
**Inlet Check
Valve Assembly**



MODEL: 110A, 110B, 112,
114M, 116, 118, 125, 126,
127, 128

CTS-A033
OEM 240619
**Check Valve
Filter Replacement Kit**



MODEL: 110A, 110B, 112

CTS-2430
OEM 243053
Sapphire Plunger



MODEL: 114M, 116,
118, 125, 126, 127, 128

CTS-2369
OEM 240714
Sapphire Plunger



MODEL: 100A,
110A, 110B

CTS-8871
OEM 887138
Plunger Seal



MODEL: 114M, 116,
118, 125, 126, 127, 128

CTS-7162
OEM 237162, 728770
Plunger Seal, Black



MODEL: 114M, 116,
118, 125, 126, 127, 128

CTS-10557
OEM 728770
Plunger Seal, Gold



MODEL: 125, 126, 127, 128

CTS-10391
OEM 728772, 238627
Plunger Wash Seal

PUMP PARTS



MODEL: ICS-3000,
ICS-5000

11-2587
OEM 063382

**Piston Seal Wash
Seal/Priming Valve Seal**



MODEL: ICS-3000,
ICS-5000

11-2588
OEM 064946

Main Piston Seal

AUTOSAMPLER



MODEL: ASI-100, ASI-100T

11-2642
OEM 6805.1334

Needle Port Seal



MODEL: ASI-100, ASI-100T

11-2643
OEM 6810.3002

ASI-100 Needle



MODEL: ASI-100, ASI-100T

11-3322
OEM 5805.2930

250µL Syringe with Seal



MODEL: WPS-3000

11-3332
OEM 6822.0002

**100µL Syringe for
WPS-3000 Series**

PUMP PARTS



MODEL: 10SC, 10WSC

CTS-10889-01

OEM (Gilson) 5463125895,
(Rainin) R007101637

Seal Assembly, Gold



MODEL: 10SC,
10WSC, 10WTi

CTS-10889-02

OEM (Gilson) 5463125095,
(Rainin) R007101636

Seal Assembly, Black



MODEL: 25SC, 25SS

CTS-11014-01

OEM (Gilson) 5463050825,
(Rainin) R007101643

Seal Assembly, Gold



MODEL: 5SC, 10SC, 10WSC,
10WTi, 25SC, H1, H2

CTS-A11211

OEM 3650180

**Check Valve Cartridge,
Outlet**



MODEL: 5SC, 10SC, 10WSC,
10WTi, 25SC, H1

CTS-A11206

OEM 3650170

**Check Valve Cartridge,
Inlet**



MODEL: 10SC, 10SS, 10Ti

CTS-11368

OEM 3650009

Piston, Sapphire

HITACHI/MERCK

PUMP PARTS



MODEL: 655, 6000, 6200, 6200A, L-7100, L-7110, L-7120, L-2130, L-2160U, L-8800, L-8800A, L-8900

CTS-10322
OEM AN0-2328 or 810-1033
Ceramic Plunger



MODEL: 655, 6000, 6200, 6200A, L-2130, L-7100, L-7110, L-7120

CTS-10394
OEM 655-1080
Pump Seal, Black



MODEL: 655, 6000, 6200, 6200A, L-2130, L-7100, L-7110, L-7120

CTS-10547
OEM 655-1080
Pump Seal, Gold



MODEL: 655, 6000, 6200, 6200A, L-2130, L-7100, L-7110

CTS-10493
OEM AN0-0835
Check Valve Cartridge, 2/pk



MODEL: 655, 6000, 6200, 6200A

CTS-A084
OEM AN0-0833 or 885-1330
Inlet Check Valve Assembly



MODEL: 655, 6000, 6200, 6200A

CTS-A085
OEM AN0-0834 or 885-1331
Outlet Check Valve Assembly



MODEL: L-2130, L-7100, L-7110

CTS-A125
OEM AN0-0836 or 810-1004
Inlet Check Valve Assembly



MODEL: L-2130, L-7100, L-7110

CTS-A126
OEM AN0-0837 or 810-1005
Outlet Check Valve Assembly

AUTOSAMPLER



MODEL: AS-7200, AS-7250

CTS-10573
OEM AN0-0818
Injection Valve Rotor Seal



MODEL: AS-7200, AS-7250, L-8800

CTS-A124
OEM 810-3095
Dilutor Valve Seal

PUMP PARTS

JASCO



MODEL: 880, 980, 1580,
2080, 2086, 2089

CTS-10971
OEM 6560-405A
6778-H109A

Inlet Check Valve



MODEL: 880, 980, 1580,
2080, 2086, 2089

CTS-10972
OEM 6560-404A
6778-H110A

Outlet Check Valve



MODEL: 880, 980,
1580, 2080, 2086, 2089

CTS-10955
OEM 2305-0005A

Sapphire Plunger



MODEL: 880, 980,
1580, 2080, 2086, 2089

CTS-11027
OEM 6560-H148-PE

Pump Seal, Gold, 2/pk

INJECTOR VALVE

RHEODYNE



MODEL: 7010,
7040, 7000, 7067

CTS-A083
OEM 7010-039

Rotor Seal, Vespel®



MODEL: 7125, 7126,
7725, 7725i, 9725

CTS-A019
OEM 7125-047

Rotor Seal, Vespel®



MODEL: 7010, 7725, 7725i,
9725, 9725i, 3725-038,
3725i-038, 3725, 3725i

CTS-10612
OEM 7010-015

Isolation Seal



MODEL: 7725, 7725i, 7726,
9725, 9725i

CTS-A11329
OEM 7725-026

Stator Face Assembly

PERKINELMER, ABI

PUMP PARTS



MODEL: 200 SERIES,
1, 2, 3, 3B, 4, 10, 250, 400,
410, 620, INT. 4000

CTS-10758
OEM 09907324

**Pump Seal,
High Pressure**



MODEL: 200 SERIES,
1, 2, 3, 3B, 4, 10, 250, 400,
410, 620, INT. 4000

CTS-10772
OEM 09907339

**Pump Seal,
Low Pressure**



CTS-10757
OEM 02540275

**High Pressure
Seal Kit **KIT****

- Pump Seal (CTS-10758) 4
- Backup Ring (CTS-10759) 4
- O-Ring (CTS-00230-02) 4



MODEL: 200 SERIES,
1, 2, 3, 3B, 4, 10, 250, 400,
410, 620, INT. 4000, SERIES
200 MICROPUMP

CTS-A159
OEM 02540177

Inlet Check Valve



MODEL: 200 SERIES,
1, 2, 3, 3B, 4, 10, 250,
400, 410, 620, INT. 4000,
SERIES 200 MICROPUMP

CTS-A157
OEM 02540197

Outlet Check Valve



MODEL: 200 SERIES

CTS-11265 **KIT**
OEM N2910383

**S200 Standard
Pump Seals Kit**



MODEL: 200 SERIES,
1, 2, 3, 3B, 4, 10, 250, 400,
410, 620, INT. 4000

11-1240
OEM ED020005

**Nut, PEEK™ Fingertight
1/16", 10/pk**



MODEL: SERIES 4, INT. 4000,
SERIES 200, 400, 410, MODEL
250 AND 620 PUMPS BUILT
AFTER DECEMBER 1989

CTS-11367
OEM N2600104

Piston, Low Pressure



MODEL: SERIES 4, INT. 4000,
SERIES 200, 400, 410, MODEL
250 AND 620 PUMPS BUILT
AFTER DECEMBER 1989

CTS-11366
OEM N2600124

Piston, High Pressure



MODEL: 200 SERIES,
1, 2, 3, 3B, 4, 10, 250, 400,
410, 620, INT. 4000

CTS-00230-02
OEM 09902128

O-Ring, PTFE



MODEL: 200 SERIES,
1, 2, 3, 3B, 4, 10, 250, 400,
410, 620, INT. 4000

CTS-10759
OEM 02542076

Piston Seal Backup Ring

AUTOSAMPLER



MODEL: 200 SERIES

CTS-A168
OEM 09923270
250 μ L Syringe



MODEL: 200 SERIES

CTS-A019
OEM 09904802
Rotor Seal



MODEL: 200 SERIES

CTS-A11329
OEM 7725-026
Stator Face Assembly



MODEL: 200 SERIES

CTS-10724
OEM N2930023
Injector Needle

DETECTOR LAMPS



MODEL: 200 SERIES, 785A

CTS-00025
OEM N2920149
Deuterium Lamp (1000 hr)



MODEL: BIO 19, LAMBDA 2,
5, 7, 9, 10, 11, 12, 14, 15, 16, 17,
18, 19, 20, 40, 800, 900

CTS-10854
OEM Old B0160917, L6022728
Deuterium Lamp (1500 hr)

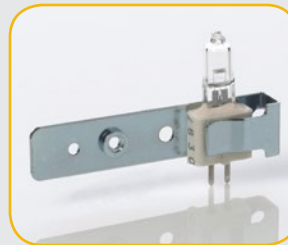

MODEL: LC-480 PDA,
LAMBDA BIO, LAMBDA 2,
10, 11, 12, 14, 15, 16, 17, 18, 19,
20, 25, 35, 40, 45, 550, 551,
552, 552A, 553, 559, 559A,
800, 900

11-3343
OEM B0114620
Tungsten Lamp

PUMP PARTS



MODEL: LC-7A, LC-10AS

CTS-10319
OEM 228-17019-93

Sapphire Plunger



MODEL: LC-10ATvp

CTS-10584
OEM 228-35009-92

Ceramic Plunger Assembly



MODEL: LC-9A,
LC-10AD, LC-600

CTS-10320
OEM 228-18523-91

Sapphire Plunger



MODEL: LC-20AT

CTS-11425
OEM 228-35009-93

Sapphire Plunger



MODEL: LC-10ADvp,
LC-20AD/AB, LC-20ADXR,
LC-30ADSF, LC-2010

CTS-11297
OEM 228-35601-93

Sapphire Plunger



MODEL: LC-6A

CTS-0422
OEM 228-11999-00

Plunger Seal



MODEL: LC-10ADvp,
LC-20AD/AB, LC-20ADXR,
LC-30ADSF, LC-2010

11-3795
OEM 228-35281-95

Sapphire Plunger w/Holder



MODEL: LC-7A,
LC-10Ai, LC-10AS,
LC-10AT, LC-10ATvp

CTS-10340
OEM 228-21975-00

Plunger Seal



MODEL: LC-10ADvp

CTS-A138
OEM 228-35601-91

Ceramic Plunger Assembly



MODEL: LC-9A, LC-10AD,
LC-10ADvp, LC-20AD/AB,
LC-600, LC-2010 A/C HT

CTS-10693
OEM 228-35146-00
Old# 228-18745-00

Plunger Seal



MODEL: LC-10ADvp,
LC-20AB, LC-20AD,
LC-20ADXR, LC-30AD,
LC-2010

11-3897
OEM 228-35602-91

Plunger Holder



MODEL: LC-10ATvp, LC-20AT,
LC-2010 A/C HT, LC-HT,
SIL-10ADvp, SIL-20A/AC,
SIL-30AC, SIL-30ACMP,
SIL-2010 A/C HT

CTS-10694
OEM 228-35145-00

Plunger Seal

PUMP PARTS



MODEL: LC-10Ai, LC-10AS,
LC-10AT, LC-10ATvp

CTS-10583
OEM 228-28499-00
Plunger Rinse Seal



MODEL: LC-9A,
LC-10AD, LC-600

CTS-A102
OEM 228-33492-91
Old# 228-18522-91
Inlet Check Valve



MODEL: LC-10ADvp,
LC-20AD/AB

CTS-10963
OEM 228-32628-00
Gold Plunger Seal



MODEL: LC-9A, LC-10AD,
LC-10AT, LC-600

CTS-A103
OEM 228-32531-92
Old# 228-18522-92
Outlet Check Valve



MODEL: LC-10AD, LC-10ADvp,
LC-20AD/AB, LC-30ADSF,
LC-2010, LC-2010 HT

11-2891
OEM 228-32784-91
Old# 228-24311-01,
228-31828-00
PTFE Diaphragm, 2/pk



MODEL: LC-20AD/AB,
LC-20ADXR, LC-20AT,
LC-20AR, LC-10AT, LC-10ADvp,
LC-10ATvp, LC-30AD

CTS-A11316
OEM 228-45707-91
**Suction Filter,
Stainless Improved**



MODEL: LC-6A, LC-10AS

CTS-A099
OEM 228-12353-91
Inlet Check Valve



MODEL: LC-10AT,
LC-10ATvp

CTS-A117
OEM 228-32166-91
Inlet Check Valve



MODEL: LC-6A, LC-8A,
LC-10AS

CTS-A100
OEM 228-09054-93
Outlet Check Valve



MODEL: LC-10ADvp

CTS-A145
OEM 228-39093-92
Inlet Check Valve



MODEL: LC-6A, LC-10AS

CTS-10595 KIT
OEM 228-11200-91
Check Valve Rebuild Kit
(for 2 Valves)

- Ruby Balls 2
- Seats 2
- Thin Washers 2
- Thick Washers 2
- Retainer Washers 2



MODEL: LC-10ADvp,
LC-10ATvp

CTS-A121
OEM 228-34976-91
Outlet Check Valve

PUMP PARTS



MODEL: LC-20AD/AB XR,
LC-20AT, LC-30ADSF

CTS-A11186

OEM 228-48249-91
Old# 228-45704-91,
228-45557-91

Inlet Check Valve



MODEL: LC-10AD,
LC-10ADvp, LC-10ATvp,
LC-20AD/B, LC-20AT

CTS-11305

OEM 228-48607-91
Old# 228-32744-00

PEEK™ 5µm Filter



MODEL: I-SERIES,
LC-10ADvp, LC-10ATvp,
LC-20AD/AB XR,
LC-30ADSF

CTS-A11187

OEM 228-45705-91
Old# 228-45563-95

Outlet Check Valve



MODEL: LC-10ADvp, LC-10AT,
LC-10ATvp, LC-20AD/AB,
LC-20ADXR, LC-20AR,
LC-20AT, LC-30AD

CTS-A11421

OEM 228-35871-96

Line Filter Assembly



MODEL: LC-20AT

11-3807

OEM 228-45704-92

Inlet Check Valve, Primary

AUTOSAMPLER



MODEL: SIL-10A,
SIL-10Ai, SIL-10AXL

CTS-10578
OEM 228-25237-04
Syringe, 500µL



MODEL: SIL-10ADvp

CTS-10942
OEM 228-21217-97
Rotor Seal



MODEL: LC-2010,
SIL-10ADvp, SIL-10AXL

CTS-10686
OEM 228-33355-04
Needle Seal, Vespel®



MODEL: SIL-10A,
SIL-10Ai, SIL-10AXL

CTS-A106
OEM 228-21217-91
Rotor Seal



MODEL: SIL-10ADvp,
SIL-10AXL/vp, SIL-HT

CTS-11435
OEM 228-33355-01
Seal, Needle PEEK™



MODEL: SIL-10A,
SIL-10Ai, SIL-10AXL

CTS-A067
OEM 228-21220-91
Stator Assembly



MODEL: SIL-20 A/C,
SIL-20ACHT, SIL-HT

CTS-11312
OEM 228-41310-92
PEEK™ Rotor, HPV



MODEL: LC-2010 A/C HT,
LC-HT, SIL-10ADvp,
SIL-20A/AC, SIL-30AC,
SIL-30ACMP

CTS-11434
OEM 228-35010-91
Sapphire Plunger



MODEL: LC-2010,
LC-2010 HT, SIL-20 A/C,
SIL-20ACHT, SIL-20ACXR,
SIL-HT

CTS-11313
OEM 228-36923-00
PEEK™ Rotor, LPV



MODEL: LC-10ATvp, LC-20AT,
LC-2010 A/C HT, LC-HT,
SIL-10ADvp, SIL-20A/AC,
SIL-20ACHT, SIL-30AC,
SIL-30ACMP

CTS-10694
OEM 228-35145-00
Plunger Seal



MODEL: SIL-20 A/C,
SIL-20ACHT

CTS-11315
OEM 228-42325-01
**Needle Seal,
PEEK™ SIL-20**

DETECTOR LAMPS



MODEL: SPD-10A,
SPD-10AV, SPD-10AVvp,
SPD-20AV

CTS-00135
OEM 228-34016-02
Deuterium Lamp (2000 hr)

THERMO ELECTRON AND SPECTRA-PHYSICS

PUMP PARTS



MODEL: 8800, 8810, P1000, P2000, P4000, ISOCHROM

CTS-3102
OEM A3102-010

Sapphire Plunger



MODEL: P1000, P2000, P4000

CTS-10396
OEM A4848-010

Washer



MODEL: 8800, 8810, P1000, P2000, P4000, ISOCHROM

CTS-2962
OEM A2962-010

Plunger Seal, Gold



MODEL: CONSTAMETRIC I, II, III, CM3000, CM3200, CM3500, CM4000, CM4100

CTS-A079
OEM 801892001

Plunger Seal Kit, Gold



MODEL: 8800, 8810, P1000, P2000, P4000, ISOCHROM

CTS-2963
OEM A2963-010

Backup Seal



MODEL: CONSTAMETRIC I, II, III, CM3000, CM3200, CM3500, CM4000, CM4100

CTS-7000
OEM 801306

Sapphire Plunger



MODEL: 8800, 8810, P1000, P2000, P4000, ISOCHROM

CTS-3495
OEM A3495-010

Inlet Check Valve



MODEL: CONSTAMETRIC I, II, III, CM3000, CM3200, CM3500, CM4000, CM4100

CTS-A091
OEM 900946

Check Valve Cartridge



MODEL: P1000, P2000, P4000

CTS-3990
OEM A3990-010

Transducer Check Valve Assembly



MODEL: CONSTAMETRIC I, II, III, CM3000, CM3200, CM3500, CM4000, CM4100

CTS-2061
OEM 206156001

Plunger Seal, Gold



MODEL: 8700, 8800, 8810, ISOCHROM

CTS-3490
OEM A3490-010

Outlet Check Valve

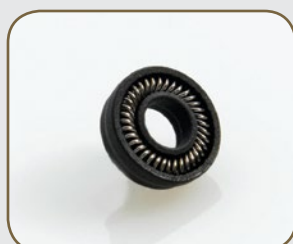

MODEL: CONSTAMETRIC I, II, III, CM3000, CM3200, CM3500, CM4000, CM4100

CTS-20612
OEM 206129001

Plunger Seal, Black

THERMO ELECTRON AND SPECTRA-PHYSICS

AUTOSAMPLER



MODEL: 8800 SERIES

CTS-10517
OEM 3301-0100
Syringe, 500µL



MODEL: AS100, AS300, AS1000, AS3000, AS3500, 8875, 8880

CTS-A096
OEM A3588-020
Syringe Assembly, 250µL



MODEL: AS100, AS300, AS1000, AS3000, AS3500, 8875, 8880, 8800 SERIES

CTS-A083
OEM 2508-0360
Rotor Seal, Vespel®



MODEL: AS100, AS300, AS1000, AS3000, AS3500, 8875, 8880, 8800 SERIES

CTS-10612
OEM 7010-015
Isolation Seal, Rheodyne 7010

DETECTOR LAMPS



MODEL: 200, 201, 203, 204, 205, 206, 206PH, CE100, CE500, CE1000, CE2000, SP100, SP200, SPECTRACHROM 200, UV100, UV150, UV200, UV1000, UV2000, UV3000

CTS-00246
OEM 9551-0023
Deuterium Lamp (1000 hr)



MODEL: UV6000
CTS-A123
OEM 108052
Lamp Assembly, TSP UV6000 Detector

SURVEYOR PLUS SYSTEMS



MODEL: SURVEYOR PLUS
11-1596
OEM 00950-01-00087
Piston Assembly, Sapphire



MODEL: SURVEYOR PLUS
11-1597
OEM 00950-30020
Piston Assembly, TZP



MODEL: SURVEYOR PLUS
11-1598
OEM 00950-30026
Check Valve Assembly, Inlet



MODEL: SURVEYOR PLUS
11-1599
OEM 00950-30021
Check Valve Assembly, Outlet



MODEL: SURVEYOR PLUS
11-1600
OEM 00950-01-00085
Check Valve, Secondary Inlet



MODEL: SURVEYOR PLUS
11-3943
OEM 00950-01-00086
Check Valve, Primary Inlet

THERMO ELECTRON AND SPECTRA-PHYSICS

SURVEYOR PLUS SYSTEMS



MODEL: SURVEYOR PLUS

11-1601

OEM 00107-18008

Seal, GFP, High Pressure, Piston



MODEL: SURVEYOR PLUS

11-1603

OEM 00950-30025

Seal, Wash



MODEL: SURVEYOR PLUS

11-1602

OEM 00950-30004

Seal, Polyethylene, High Pressure, Piston



MODEL: SURVEYOR PLUS

11-1604

OEM 00950-30009

Line Filter Frit

PUMP PARTS

MODEL: M6KA, M45, 501, 510, 515, 590, 600, 610, 1515, 1525, LC MODULE 1, PREP LC-4000



MODEL: (#4, #5 HEADS),
PREP LC-4000

CTS-A136
OEM WAT033325

**Inlet Check Valve,
#4, #5 Heads**



MODEL: M6KA, 510, 515,
600, 610, LC MODULE 1

CTS-0106
OEM WAT025203

Inlet Check Valve Housing



MODEL: (#4, #5, #6 HEADS),
PREP LC-4000

CTS-3326
OEM WAT033326

Outlet Check Valve



MODEL: M6KA, 510, 515,
600, 610, LC MODULE 1

CTS-0110 KIT
OEM WAT060495

Inlet Check Valve Rebuild Kit
rebuilds 2 valves

- Blue Washer (CTS-0101) 2
- Gasket, Retainer (CTS-0102) 2
- Insert, PCTFE (CTS-0103) 2
- Check Ball & Seat 0.125" (CTS-0104) 2
- Washer, TFE (CTS-0105) 2



MODEL: 510, 515, 525,
600, 610, 1515, 1525

CTS-A142
**Cartridge Check Valve
Housing (use w/CTS-10600
or 11-2401)**



MODEL: 510, 600,
LC MODULE 1

CTS-8223
OEM WAT088223

**Check Valve Rebuild
Kit - Extended Flow**
rebuilds 2 valves



MODEL: 510, 515, 600, 610,
1515, 1525, 2690, 2690D,
2695, 2695D, 2795

CTS-10600
OEM 70000254
Check Valve Cartridge, 2/pk



MODEL: M6KA, 510

CTS-0200
OEM WAT025028

**Outlet Check Valve
Assembly - Actuator Style**



MODEL: 510, 515, 600, 610,
1515, 1525, 2690, 2690D,
2695, 2695D, 2795

11-2401
OEM 700002399
**Check Valve Cartridge,
Ceramic Ball & Seat, 2/pk**



MODEL: M6KA, 510

CTS-0201
OEM WAT025212

**Outlet Housing -
Actuator Style**



MODEL: M6KA, 510, 515,
600, 610, LC MODULE 1

CTS-0100
OEM WAT033679

**Inlet Check Valve
Assembly**



MODEL: M6KA, 510

CTS-0210
OEM WAT026016

**Outlet Check Valve
Rebuild Kit - Actuator Style**
rebuilds 2 valves

WATERS

PUMP PARTS

MODEL: M6KA, M45, 501, 510, 515, 590, 600, 610, 1515, 1525, LC MODULE 1, PREP LC-4000



MODEL: 510, 515, 600, 610, 1525EF, LC MODULE 1

CTS-0300
OEM WAT025216
Outlet Check Valve Assembly - Ball & Seat



MODEL: 510, 515, 600, 610, 1515, 1525, LC MODULE 1

CTS-6613
OEM WAT026613
Plunger Seal, Black



MODEL: 510, 515, 600, 610, 1525EF, LC MODULE 1

CTS-0301
OEM WAT025207
Outlet Check Valve Housing - Ball & Seat



MODEL: 510, 515, 600, 610, 1515, 1525, LC MODULE 1

CTS-10548
Gold Plunger Seal, Analytical Heads



MODEL: 510, 515, 600, 610, 1525EF, LC MODULE 1

CTS-0310 KIT
OEM WAT026014
Outlet Check Valve Rebuild Kit - Ball & Seat
rebuilds 2 valves



MODEL: 510, 515, 590, 600, 610, LC MODULE 1

CTS-6644
OEM WAT026644
Black Plunger Seal, EF Heads



MODEL: 510, 515, 600, 610, 1525EF, LC MODULE 1, PREP LC-4000

CTS-0307
OEM WAT060307
Inlet Check Valve Assembly - Extended Flow, 225µL



MODEL: M6KA, 510, 515, 600, 610, 1515, 1525, LC MODULE 1

CTS-2294
OEM WAT022934
Plunger Seal



MODEL: M6KA, 510, 515, 590, 600, 610, 1515, 1525

CTS-2294-04
OEM WAT022946
Plunger Seals

OUTLET CHECK VALVES

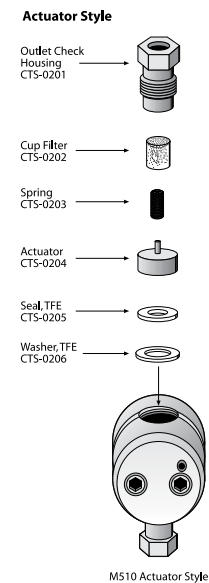
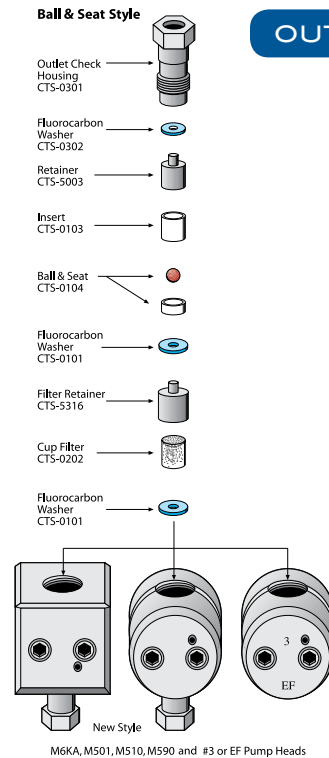

PUMP PARTS

MODEL: M6KA, M45, 501, 510, 515, 590, 600, 610, 1515, 1525, LC MODULE 1, PREP LC-4000



MODEL: 510, 515, 590, 600, LC MODULE 1

CTS-10832
OEM WAT026644
Gold Plunger Seal, EF Heads



MODEL: M6KA, 510, 590, 600

CTS-5464
OEM WAT025464
Clip Ring, Plunger Retainer



MODEL: 510, 515, 590, 600, 610, 1525EF, LC MODULE 1

CTS-6030
OEM WAT060304
Sapphire Plunger, Extended Flow



MODEL: M6KA, 510, 590, 600, 626, 1515, 1515 MICRO, 1525, LC MODULE 1

CTS-5669
OEM WAT025669
WAT005081
Oil Seal



MODEL: M6KA, 510, 590, 600, 610, LC MODULE 1

CTS-5656
OEM WAT025656, WAT069511
Sapphire Plunger



MODEL: M6KA, 510, 515, 590, 600

CTS-0037
OEM WAT060037
Tube, Left Inlet Pigtail



MODEL: M6KA, 510, 590, 600, 610, LC MODULE 1

CTS-1042
OEM WAT011042
Plunger Insertion Tool



MODEL: M6KA, 510, 515, 590, 600

CTS-0038
OEM WAT060038
Tube, Right Inlet Pigtail



MODEL: 515, 1515, 1525

CTS-10475
Sapphire Plunger Kit



MODEL: 510, 515, 600, 610, LC MODULE 1

CTS-0069L
OEM WAT060069
Tube, Left Outlet Pigtail



MODEL: 515, 1515, 1525

CTS-10475-1
OEM WAS207069
Sapphire Plunger



MODEL: 510, 515, 600, 610, LC MODULE 1

CTS-0069R
OEM WAT060069
Tube, Right Outlet Pigtail

WATERS

PUMP PARTS

MODEL: M6KA, M45, 501, 510, 515, 590, 600, 610, 1515, 1525, LC MODULE 1, PREP LC-4000



CTS-2330
OEM WAT022330
Ferrule, SS



CTS-6809
OEM WAT026809
Mobile Phase Transfer Line, TFE, 3/16" OD x 1/8" OD x 25'



MODEL: 710, 712, 715, 717, 2690, 2690D, 2695, 2695D, 2790, 2795
CTS-5313
OEM WAT025313
Compression Screw, SS



MODEL: M6KA, 510, 515, 590, 600, 610
CTS-5559
OEM WAT025559
Priming Syringe Needle



CTS-9733
OEM WAT097332
SS Union, Zero Dead Volume



MODEL: M6KA, 510, 515, 590, 600, 610
CTS-5740
OEM WAT060476
Draw-Off Tube Assembly



11-2610
Tubing Stainless Steel
1/16" OD x 0.50mm (0.020") ID x 10ft



MODEL: 510, 515, 600, 610, 1515, 1525
CTS-6958
OEM WAT069583
Indicator Rod Kit



11-2611
Tubing Stainless Steel
1/16" OD x 1mm (0.040") ID x 10ft



11-2612
Tubing Stainless Steel
1/16" OD x 250µm (0.010") ID x 10ft

PUMP PARTS

MODEL: M6KA, M45, 501, 510, 515, 590, 600, 610, 1515, 1525, LC MODULE 1, PREP LC-4000



MODEL: 510
CTS-0012 KIT
 OEM WAT060012
Insert Seal Parts Kit

- Manifold Insert (CTS-0015) 1
- Insert Seal, TFE (CTS-0016) 1
- Belleville Washer (CTS-9503) 2
- Flat Washer (CTS-9854) 1



MODEL: 500, 515, 600, 1515, 1525
CTS-5746 KIT
 OEM WAT025746
Reference Valve Rebuild Kit

- Button, Reference Valve 1
- Spacer, Valve Disk 1
- Diaphragm, Reference Valve 1



MODEL: 510
CTS-1106
 OEM WAT010106
Inlet Tube Assembly w/Ball & Seat



MODEL: M45, 501, 510, 590
CTS-0058
 OEM WAT060058
Round Pump Head w/Actuator Outlet Check Valve



MODEL: 510, 590, 600
CTS-0068
Round Pump Head w/Ball & Seat Outlet Check Valve



MODEL: M45, 501, 510, 515, 590, 600, 610
CTS-9600 KIT
 OEM WAT060448
Inlet Manifold Kit

- Ball Plug, TFE (CTS-0040) 1
- Seat, TFE 1
- Ruby Ball 1
- Insert Seal Body Part Kit (CTS-0012) 1
- Inlet Tube Body Assembly (CTS-1106) 1

SINGLE SOLVENT MANIFOLD

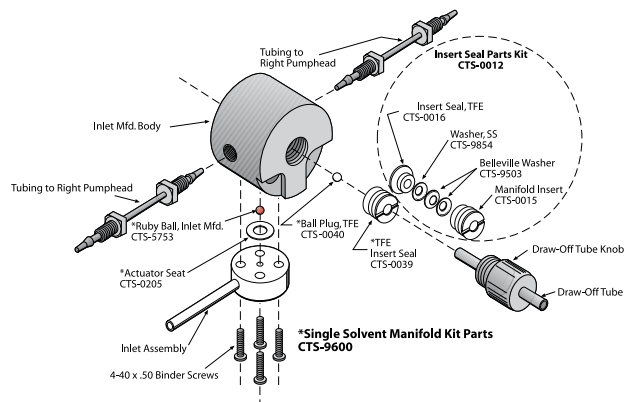

PUMP PARTS

MODEL: M6KA, M45, 501, 510, 515, 590, 600, 610, 1515, 1525, LC MODULE 1, PREP LC-4000



MODEL: 510, 590, 600

CTS-1068
Round Pump Head
w/o Check Valves,
Ball & Seat Style



MODEL: 1515

CTS-11294 KIT
 OEM 201000113

1515 Performance
Maintenance Kit

- Sapphire Plunger (CTS-10475-1) 2
- PP Check Valve Cartridge, 2/pk (CTS-10600) 2
- Plunger Seal (CTS-2294) 2
- Solvent Reservoir Filter, 10µm (CTS-5531) 1
- Reference Valve Rebuild Kit (CTS-5746) 1



MODEL: 510

CTS-11009 KIT
 OEM WAT052670

510 Performance
Maintenance Kit

- Actuator Outlet Rebuild Kit (CTS-0210) 1
- PP Check Valve Cartridge, 2/pk (CTS-10600) 1
- Plunger Seal (CTS-2294) 2
- Solvent Reservoir Filter, 10µm (CTS-5531) 1
- Sapphire Plunger (CTS-5656) 2
- Reference Valve Rebuild Kit (CTS-5746) 2
- Inlet Manifold Kit (CTS-9600) 1



MODEL: 1525

CTS-11282 KIT
 OEM 201000114

1525 Performance
Maintenance Kit

- Sapphire Plunger (CTS-10475-1) 4
- PP Check Valve Cartridge, 2/pk (CTS-10600) 4
- Plunger Seal (CTS-2294) 4
- Solvent Reservoir Filter, 10µm (CTS-5531) 2
- Reference Valve Rebuild Kit (CTS-5746) 1



MODEL: 515

CTS-11010 KIT
 OEM WAT052587

515 Performance
Maintenance Kit

- Solvent Reservoir Filter, 10µm (CTS-5531) 1
- PP Check Valve Cartridge, 2/pk (CTS-10600) 1
- Sapphire Plunger Kit (CTS-10475) 2
- Plunger Seal (CTS-2294) 2
- Sparge Diffuser (CTS-10984) 1



CTS-10985 KIT
 OEM WAT052675

600/610 Performance
Maintenance Kit

- Solvent Reservoir Filter, 10µm (CTS-5531) 4
- PP Check Valve Cartridge, 2/pk (CTS-10600) 2
- Sapphire Plunger (CTS-5656) 2
- Plunger Seal (CTS-2294) 2
- Sparge Diffuser (CTS-10984) 4
- Reference Valve Rebuild Kit (CTS-5746) 1
- Inlet Manifold Kit (CTS-9600) 1

PUMP PARTS

MODEL: 616, 625, 626, 1515 MICRO



MODEL: 616
CTS-A057
 OEM WAT024960
Check Valve Cartridge



MODEL: 625, 626
CTS-A058
 OEM WAT024120
Check Valve Cartridge, PEEK™



MODEL: 616, 625, 626
CTS-11032 KIT
 OEM WAT031790
Plunger and Wash Seal, Rebuild Kit

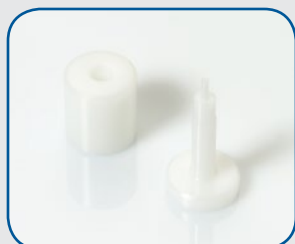

MODEL: 616, 625, 626, 1525 MICRO
CTS-11296
 OEM WAT088726
Seal Insertion/Extraction Tool



MODEL: 616, 625, 626, 1525 MICRO
CTS-10323
 OEM WAT031788, WAT030547
Sapphire Plunger
Note: Does not include compression spring, plunger spring, and indicator rod.



MODEL: 616, 1525 MICRO
CTS-10906 KIT
 OEM WAT034515
Seal Kit

- Plunger Seals 2
- Plunger Wash Seals 2
- O-Rings 2
- Backup Rings 2



MODEL: 616
CTS-10986 KIT
 OEM WAT052672
616 Performance Maintenance Kit

- Sapphire Plunger (CTS-10323) 2
- Sparge Diffuser (CTS-10984) 4
- Solvent Reservoir Filter, 10µm (CTS-5531) 4
- Pump Seal Kit (CTS-10906) 1
- Check Valve Cartridge (CTS-A057) 4

Note: Does not include compression spring, plunger spring, and indicator rod.



MODEL: 626
CTS-11026 KIT
 OEM WAT052673
626 Performance Maintenance Kit

- Sapphire Plunger (CTS-10323) 2
- Sparge Diffuser (CTS-10984) 4
- Solvent Reservoir Filter, 10µm (CTS-5531) 4
- Pump Seal Kit (CTS-11032) 1
- Check Valve Cartridge (CTS-A058) 4

Note: Does not include compression spring, plunger spring, and indicator rod.



MODEL: 600, 610, 510, 515, 1515, 1525, 1525EF, 1525 MICRO, 2535, 2545, 2555, 2690, 2690D, 2695, 2695D, 2700, ACQUITY, LC MODULE 1
CTS-5531
 OEM WAT025531
Solvent Reservoir Filter, 10µm

PUMP PARTS

MODEL: 2690, 2690D, 2695, 2695D, 2790, 2795, 2796



MODEL: 2690, 2690D,
2695, 2695D, 2790, 2795
CTS-10566
OEM WAT270938, (2 of WAT270789)
**Head Plunger
Seal Kit, Alliance, 2/pk**



MODEL: 2690, 2690D,
2695, 2695D, 2795 510,
515, 600, 610, 1515, 1525
11-2401
OEM 700002399
**Check Valve Cartridge,
Ceramic Ball & Seat, 2/pk**



MODEL: 2690, 2690D,
2695, 2695D, 2790, 2795
CTS-10711
OEM WAT271066
**Head Plunger Seal Kit,
Black, Alliance, 2/pk**



MODEL: 2690, 2690D,
2695, 2695D, 2795 510,
515, 600, 610, 1515, 1525
CTS-10600
OEM 700000254
**Check Valve
Cartridge, 2/pk**



MODEL: 2690, 2690D,
2695, 2695D, 2790, 2795
CTS-10560
OEM WAT271018, (2 of WAT270160)
**Seal Wash Plunger
Seal, Alliance, 2/pk**



MODEL: 2690, 2690D,
2695, 2695D, 2790,
2795, 2796
CTS-10476
OEM WAT270959, WAT271067,
WAT270488
Sapphire Plunger, Alliance



MODEL: 2690, 2690D,
2695, 2695D, 2790, 2795
CTS-10989
OEM WAT270939, (4 of WAT270163)
Face Seals, 4/pk



MODEL: 2690, 2690D,
2695, 2695D, 2790, 2795,
2796, 515, 600, 610, 626,
LC MODULE 1
CTS-10984
OEM WAT007272
Sparge Diffuser



MODEL: 2690, 2690D,
2695, 2695D, 2790, 2795
CTS-10597
OEM WAT270940, (4 of WAT270668)
Wash Tube Seal Kit, 4/pk



MODEL: 2690, 2690D,
2695, 2695D, 2790, 2795,
717, LC MODULE 1
CTS-10919
OEM WAT088084
**2µm Precolumn
Filter Insert**



MODEL: 2690, 2690D,
2695, 2695D, 2790, 2795
CTS-10532
OEM WAT271017
Seal Wash Face Seal



MODEL: 2690, 2690D,
2695, 2695D, 2790, 2795,
717, LC MODULE 1
CTS-10919-5
OEM WAT005139
**2µm Precolumn
Filter Insert, 5/pk**

PUMP PARTS

MODEL: 2690, 2690D, 2695, 2695D, 2790, 2795, 2796



MODEL: 2690, 2690D, 2695,
2695D, 2790, 2795

CTS-A094
OEM WAT270941

Check Valve Cartridge, 2/pk



CTS-9733

OEM WAT097332

**SS Union,
Zero Dead Volume**



MODEL: 2690, 2690D, 2695,
2695D, 2790, 2795

CTS-A11431-02
OEM 700002332

**Cartridge Check Valve
Housing, 2/pk**



11-2610

**Tubing Stainless Steel
1/16" OD x 0.50mm
(0.020") ID x 10ft**



MODEL: 2690, 2690D, 2695,
2695D, 2700, 2535, 2545, 2555,
510, 515, 600, 610, 1515, 1525,
1525EF, 1525 MICRO, ACQUITY,
LC MODULE 1

CTS-5531
OEM WAT025531

**Solvent Reservoir Filter,
10µm**



11-2611

**Tubing Stainless
Steel 1/16" OD x 1mm
(0.040") ID x 10ft**



MODEL: 2690, 2690D,
2695, 2695D, 2790, 2795,
717, LC MODULE 1

CTS-10527
OEM WAT084561 or WAT035190

Precolumn Filter Assembly



11-2612

**Tubing Stainless Steel
1/16" OD x 250µm
(0.010") x 10ft**



CTS-2330
OEM WAT022330

Ferrule, SS



CTS-6809

OEM WAT026809

**Mobile Phase Transfer
Line, TFE, 3/16" OD x
1/8" OD x 25'**



MODEL: 2690, 2690D,
2695, 2695D, 2790, 2795,
710, 712, 715, 717

CTS-5313
OEM WAT025313

Compression Screw, SS



MODEL: 2690, 2690D,
2695, 2695D, 484, 486, 717

CTS-10945
OEM WAT080443

Battery

PUMP PARTS & AUTOSAMPLER

MODEL: 717, 2690, 2690D, 2695, 2695D, 2790, 2795, 2796



MODEL: 2690, 2690D, 2695, 2695D, 2790, 2795

CTS-11080 **KIT**

OEM 700004073

Alliance Solvent Manager Performance Maintenance Kit

- Sapphire Plunger (CTS-10476) 2
- Seal Wash Plunger Seal Kit, 2/pk (CTS-10560) 1
- Head Plunger Seal Kit, 2/pk (CTS-10566) 1
- Wash Tube Seal Kit, 4/pk (CTS-10597) 1
- 2µm Precolumn Filter Insert (CTS-10919) 1
- Face Seal, 4/pk (CTS-10989) 1
- PP Check Valve Cartridge, 2/pk (CTS-10600) 1
- Seal Wash Face Seal (CTS-10532) 2



MODEL: 2690, 2690D, 2695, 2695D

CTS-11380 **KIT**

2690/2695 Performance Maintenance Kit w/Seal Pack

- Sapphire Plunger (CTS-10476) 2
- Seal Wash Plunger Seal Kit, 2/pk (CTS-10560) 1
- Head Plunger Seal Kit, 2/pk (CTS-10566) 1
- Wash Tube Seal Kit, 4/pk (CTS-10597) 1
- Seal Pack Assembly Kit (CTS-11222) 1
- 2µm Precolumn Filter Insert (CTS-10919) 1
- Battery (CTS-10945) 1
- Sparge Diffuser (CTS-10984) 1
- Face Seal Pack, 4/pk (CTS-10989) 1
- 250µL Syringe (CTS-3109) 1
- Solvent Reservoir Filter, 10µm (CTS-5531) 4
- PP Check Valve Cartridge, 2/pk (CTS-10600) 1



MODEL: 717, 715, 2690, 2690D, 2695, 2695D

CTS-3195

OEM WAT073195

250µL Syringe Tip



MODEL: 2690, 2690D, 2695, 2695D

CTS-10988 **KIT**

OEM WAT270944

2690/2695 Performance Maintenance Kit

- Sapphire Plunger (CTS-10476) 2
- Seal Wash Plunger Seal Kit, 2/pk (CTS-10560) 1
- Head Plunger Seal Kit, 2/pk (CTS-10566) 1
- Wash Tube Seal Kit, 4/pk (CTS-10597) 1
- Battery (CTS-10945) 1
- Sparge Diffuser (CTS-10984) 1
- Face Seal, 4/pk (CTS-10989) 1
- Solvent Reservoir Filter, 10µm (CTS-5531) 4
- 250µL Syringe (CTS-3109) 1
- 2µm Precolumn Filter Insert (CTS-10919) 1
- Seal Wash Face Seal (CTS-10532) 2
- PP Check Valve Cartridge, 2/pk (CTS-10600) 1
- Seal Pack Rebuild Kit: (CTS-10839) 1
 - Wash Tube Seal (CTS-10598) 1
 - Tube, Seal Wash (CTS-10739) 1
 - PTFE Washer (CTS-10741-01) 1
 - Filter Retainer (CTS-10785) 1
 - Lower Wash Seal Frit (CTS-10788) 1
 - Needle Wash Frit (CTS-2324) 1
 - TFE Washer (CTS-7321) 1
 - Needle Assembly (CTS-7550) 1
 - Gold Injector Seal (CTS-A047) 2
 - Ferrule, SS (CTS-2330) 1
 - Compression Screw, SS (CTS-5313) 1

PUMP PARTS & AUTOSAMPLER

MODEL: 717, 2690, 2690D, 2695, 2695D, 2790, 2795, 2796



MODEL: 717, 715, 2690, 2690D, 2695, 2695D

CTS-3209
OEM WAT077347

Syringe Seal, 250µL/2500µL



MODEL: 717, 715, 2690, 2690D, 2695, 2695D

CTS-2324
OEM WAT072324

Needle Wash Frit



MODEL: 717, 715, 2690, 2690D

CTS-10285
OEM WAT045407, WAT078800

TFE 3-Way Valve 4 (V4)



MODEL: 717

CTS-A087
OEM WAT025893

Valve 3 Solenoid Assembly



MODEL: 2690, 2690D, 2695, 2695D

CTS-10770
OEM 700001229

Waste Valve, V3 (2-Way Solenoid Valve)



MODEL: 717, 715, 2690, 2690D, 2695, 2695D

CTS-3109
OEM WAT073109
250µL Syringe



MODEL: 2690, 2690D, 2695, 2695D

CTS-11030 KIT
2690/2695 Performance Maintenance Kit (w/Assembled Seal Pack)

- | | | | |
|--|---|--|---|
| • Sapphire Plunger (CTS-10476) | 2 | • 2µm Precolumn Filter Insert (CTS-10919) | 1 |
| • Seal Wash Plunger Seal Kit, 2/pk (CTS-10560) | 1 | • Battery (CTS-10945) | 1 |
| • Head Plunger Seal Kit, 2/pk (CTS-10566) | 1 | • Sparge Diffuser (CTS-10984) | 1 |
| • Wash Tube Seal Kit, 4/pk (CTS-10597) | 1 | • Face Seal Pack, 4/pk (CTS-10989) | 1 |
| • Seal Pack Assembly w/Needle (CTS-11029) | 1 | • 250µL Syringe (CTS-3109) | 1 |
| | | • Solvent Reservoir Filter, 10µm (CTS-5531) | 4 |
| | | • PP Check Valve Cartridge, 2/pk (CTS-10600) | 1 |

WATERS

AUTOSAMPLER

MODEL: 717, 2690, 2690D, 2695, 2695D, 2790, 2795, 2796



MODEL: 2690, 2690D,
2695, 2695D
CTS-10788-5
OEM 70001318, (5 of 415000230)
Needle Wash Frit, 5/pk



MODEL: 2690, 2690D
CTS-11029 KIT
OEM WAT270942
Assembled Seal Pack



MODEL: 717, 715, 2690,
2690D, 2695, 2695D
CTS-10761 KIT
OEM WAT045424
**HPMV 1 & 2 Rebuild Kit
w/Spool**

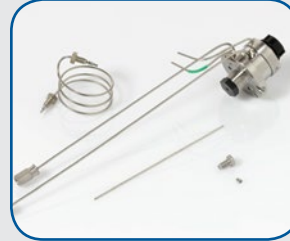

MODEL: 2690, 2690D,
2695, 2695D
CTS-11222 KIT
OEM 700002791
Seal Pack Assembly Kit

- O-Ring, TFE (CTS-1010T) 1
- HPMV Gold Seals,
2/pk (CTS-10692) 1
- Spool Assembly (CTS-A155) 1
- Bullet, Seal Insertion (CTS-11281) 1



MODEL: 717, 715, 2690,
2690D, 2695, 2695D
CTS-10692
OEM WAT045454
HPMV Gold Seals, 2/pk



MODEL: 717, 715, 2690,
2690D, 2695, 2695D
CTS-1010T
OEM WAT097387
O-Ring, TFE



MODEL: 717, 717 PLUS,
710, 712, 715, 2690, 2690D,
2695, 2695D
CTS-7550
OEM 700001247
**Performance Autosampler
Needle**



MODEL: 2690, 2690D, 2695, 2695D

CTS-10839 KIT
OEM WAT271019
Seal Pack Rebuild Kit

- Wash Tube Seal (CTS-10598) 1
- Tube, Seal Wash (CTS-10739) 1
- PTFE Washer (CTS-10741-01) 1
- Filter Retainer (CTS-10785) 1
- Lower Wash Seal Frit (CTS-10788) 1
- Needle Wash Frit (CTS-2324) 1
- TFE Washer (CTS-7321) 1
- Needle Assembly (CTS-7550) 1
- Gold Injector Seal (CTS-A047) 2
- Ferrule, SS (CTS-2330) 1
- Compression Screw, SS (CTS-5313) 1

AUTOSAMPLER

MODEL: 717, 2690, 2690D, 2695, 2695D, 2790, 2795, 2796



MODEL: 717

CTS-10987 KIT
OEM WAT052669

717 Performance Maintenance Kit

- Seal Pack Kit (CTS-10324S) 1
- 250µL Syringe (CTS-3109) 1
- Filter, Foam 45 Ppi, 2.3x11.5" (CTS-11063-02) 1
- Filter, Foam 45 Ppi, 2x7" (CTS-11063-03) 2



MODEL: 717,
LC MODULE 1

CTS-10324S
OEM WAT045559

Seal Pack w/Needle



MODEL: 717, 2690, 2690D,
2695, 2695D, 2790, 2795,
LC MODULE 1

CTS-10919
OEM WAT088084

**2µm Precolumn
Filter Insert**



MODEL: 717, 2690, 2690D,
2695, 2695D, 2790, 2795,
LC MODULE 1

CTS-10919-5
OEM WAT005139

**2µm Precolumn
Filter Insert, 5/pk**



MODEL: 717, 2690, 2690D,
2695, 2695D, 2790, 2795,
LC MODULE 1

CTS-10527
OEM WAT084561 or WAT035190

Precolumn Filter Assembly

PUMP PARTS

MODEL: ACQUITY, nanoACQUITY, H-CLASS, I-CLASS



MODEL: ACQUITY I-CLASS BSM, ACQUITY UPLC 12V BSM, ACQUITY UPLC BSM

CTS-5531-07
OEM 700003616
Solvent Bottle Filter, 7/pk



MODEL: ACQUITY H-CLASS QSM, ACQUITY UPLC 12V BSM, ACQUITY UPLC BSM, nanoACQUITY UPLC BSM/ASM

CTS-11119-02
OEM 700002599
Head Plunger Seal, 2/pk



MODEL: ACQUITY H-CLASS QSM, ACQUITY UPLC 12V BSM, ACQUITY UPLC BSM, nanoACQUITY UPLC BSM/ASM

CTS-11121-02
OEM 700002598
Wash Seal, 2/pk



MODEL: ACQUITY H-CLASS BIO QSM, ACQUITY H-CLASS QSM, ACQUITY I-CLASS BSM, ACQUITY UPLC 12V BSM, ACQUITY UPLC BSM, nanoACQUITY UPLC BSM/ASM

CTS-11093-02
OEM 700002600
Plunger, 2/pk



MODEL: ACQUITY UPLC BSM

CTS-11091 KIT

OEM 201000173

Acquity BSM Performance Maintenance Kit

- O-Ring, PTFE (CTS-11092) 4
- Plunger, 2/pk (CTS-11093-02) 2
- UPLC Primary Check Valves, 2/pk (CTS-A11094-02) 1
- UPLC Check Valve, Double Ball & Seat, 2/pk (CTS-A11095-02) 1
- Filter, Air, Pump Handle (CTS-11115) 1
- Filter, Air, Acquity Pump (CTS-11116) 1
- Head Plunger Seal, 2/pk (CTS-11119-02) 2
- Wash Seal, 2/pk (CTS-11121-02) 2
- SS Primary Inlet CV Filter (CTS-A11123) 2
- Tube Assy, SSV to In-line Filter (CTS-A11129) 2
- Tube Assembly, Transducer to Check Valve (CTS-A11133) 2
- 50µL Std. Zirconia Mixer (CTS-A11135) 1
- Solvent Bottle Filter, 7/pk (CTS-5531-07) 1



MODEL: ACQUITY UPLC I2V BSM

CTS-11371 KIT

OEM 201000197

Acquity I2V BSM Performance Maintenance Kit

- O-Ring, PTFE (CTS-11092) 4
- Plunger, 2/pk (CTS-11093-02) 2
- UPLC Check Valves, Double Ball & Seat, 2/pk (CTS-A11095-02) 1
- Filter, Air, Pump Handle (CTS-11115) 1
- Filter, Air, Acquity Pump (CTS-11116) 1
- Head Plunger Seal, 2/pk (CTS-11119-02) 2
- Wash Seal, 2/pk (CTS-11121-02) 2
- SS Filter Frit Replacement Cartridge, 2/pk (CTS-11415) 1
- 50µL Std. Zirconia Mixer (CTS-A11135) 1
- Cartridge, Intelligent Valve, 2/pk (CTS-A11336-02) 1
- Tube Assy, Transducer to Check Vlv, I2V (CTS-A11372) 2
- Tube Assy, SSV to I2V (CTS-A11374) 2
- Solvent Bottle Filter, 7/pk (CTS-5531-07) 1

PUMP PARTS

MODEL: ACQUITY, nanoACQUITY, H-CLASS, I-CLASS



MODEL: ACQUITY H-CLASS QSM

CTS-11335 KIT

OEM 201000233

Acquity H-Class QSM Performance Maintenance Kit

- | | | | |
|--|---|---|---|
| • O-Ring, PTFE (CTS-11092) | 2 | • Tube Assembly, Transducer to Check Valve (CTS-A11342) | 1 |
| • Plunger, 2/pkg (CTS-11093-02) | 1 | • Filter, GPV, 4/pkg (CTS-A11344) | 1 |
| • Check Valve, Double Ball & Seat (CTS-A11095) | 1 | • Filter, Air, Door (CTS-11370) | 1 |
| • Head Plunger Seal, 2/pk (CTS-11119-02) | 1 | • Mixer Assembly, 100µL (CTS-A11376) | 1 |
| • Wash Seal, 2/pk (CTS-11121-02) | 1 | • Solvent Reservoir Filter, 10µm (CTS-5531) | 5 |
| • Cartridge, Intelligent Valve (CTS-A11336) | 1 | | |

PUMP PARTS

MODEL: ACQUITY, nanoACQUITY, H-CLASS, I-CLASS



MODEL: ACQUITY I-CLASS BSM, ACQUITY UPLC BSM, nanoACQUITY UPLC BSM/ASM

CTS-A11094-02
OEM 700002596
UPLC Primary Check Valve Assy, 2/pk



MODEL: ACQUITY I-CLASS BSM, ACQUITY UPLC BSM

CTS-11415
OEM 700002913
SS Filter Frit Replacement Cartridge, 2/pk



MODEL: ACQUITY H-CLASS QSM

CTS-A11095
OEM 700005164
Check Valve, Double Ball & Seat



MODEL: ACQUITY UPLC I2V BSM, ACQUITY UPLC BSM

CTS-A11135
OEM 700002911
50µL Std. Zirconia Mixer



MODEL: ACQUITY I-CLASS BSM, ACQUITY UPLC I2V BSM, ACQUITY UPLC BSM, nanoACQUITY UPLC BSM/ASM

CTS-A11095-02
OEM 700002968
UPLC Check Valve, Double Ball & Seat
2/pk



MODEL: ACQUITY H-CLASS QSM

CTS-A11376
OEM 700005119
Mixer Assembly, 100µL



MODEL: ACQUITY H-CLASS QSM

CTS-A11336
OEM 700005165
Cartridge, Intelligent Valve



MODEL: ACQUITY H-CLASS QSM

CTS-A11344
OEM 700005173
Filter, GPV, 4/pk



MODEL: ACQUITY I-CLASS BSM, ACQUITY UPLC I2V BSM

CTS-A11336-02
OEM 700003563
Cartridge, Intelligent Valve, 2/pk



MODEL: ACQUITY I-CLASS BSM, ACQUITY UPLC I2V BSM

CTS-A11372
OEM 430001773
Tube Assy, Transducer to Check Valve, I2V



MODEL: ACQUITY H-CLASS QSM, ACQUITY I-CLASS BSM, ACQUITY UPLC I2V BSM, ACQUITY UPLC BSM, PREP LC-2000, nanoACQUITY UPLC BSM/ASM

CTS-11092
OEM WAT076152
O-Ring, PTFE



MODEL: ACQUITY I-CLASS BSM, ACQUITY UPLC I2V BSM

CTS-A11374
OEM 430001443
Tube Assy, SSV to I2V

PUMP PARTS

MODEL: ACQUITY, nanoACQUITY, H-CLASS, I-CLASS



MODEL: ACQUITY I-CLASS BSM, ACQUITY UPLC I2V BSM, ACQUITY UPLC BSM, nanoACQUITY UPLC BSM/ASM

CTS-A11123
OEM 289003547

SS Primary Inlet Check Valve Filter



MODEL: ACQUITY UPLC I2V BSM, ACQUITY UPLC BSM

CTS-11116
OEM 700002632

Filter, Air, Acquity Pump



MODEL: ACQUITY I-CLASS BSM, ACQUITY UPLC I2V BSM, ACQUITY UPLC BSM, nanoACQUITY UPLC BSM/ASM

CTS-A11123-02
OEM 700002912

SS Primary Inlet Check Valve Filter Kit, 2/pk



MODEL: ACQUITY H-CLASS BIO QSM, ACQUITY H-CLASS QSM

CTS-11370
OEM 700005167

Filter, Air, Door



MODEL: nanoACQUITY UPLC BSM/ASM, nanoACQUITY UPLC w/2D TECHNOLOGY

CTS-A11129
OEM 430001470

Tube Assy, SSV to In-line Filter



MODEL: ACQUITY H-CLASS QSM

CTS-A11342
OEM 430002357

Tube Assembly, Transducer to Check Valve



MODEL: ACQUITY UPLC BSM, nanoACQUITY UPLC BSM/ASM

CTS-A11133
OEM 430001121

Tube Assembly, Transducer to Check Valve



MODEL: ACQUITY UPLC HIGH TEMPERATURE COLUMN HEATER, ACQUITY UPLC COLUMN HEATER MODULE, ACQUITY UPLC COLUMN HEATER/COOLER, ACQUITY UPLC COLUMN MANAGER

11-2414
OEM 700003114

PEEK™ Ferrule, 1/16", 10/pk

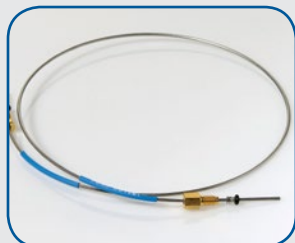

MODEL: ACQUITY UPLC BSM, OPEN ARCHITECTURE UPLC, UPLC W/ONLINE SPE TECHNOLOGY

CTS-A11145
OEM 430001486

Tube Assy, System Outlet, SDS



MODEL: ACQUITY UPLC I2V BSM, ACQUITY UPLC BSM

CTS-11115
OEM 700002633

Filter, Air, Pump Handle

PUMP PARTS

MODEL: ACQUITY, nanoACQUITY, H-CLASS, I-CLASS



MODEL: ACQUITY H-CLASS BIO QSM, ACQUITY I-CLASS BSM, ACQUITY UPLC BSM, OPEN ARCHITECTURE UPLC, nanoACQUITY UPLC SAMPLE MGR

11-2525
OEM 700002634

1/4" Short Comp. Screw (Gold-Plated), 10/pk



MODEL: ACQUITY H-CLASS BIO QSM, ACQUITY I-CLASS BSM, ACQUITY UPLC BSM, OPEN ARCHITECTURE UPLC, nanoACQUITY UPLC BSM/ASM

11-2529
OEM 700002645

Screw, Comp., 10-32, 304SS, (Gold-Plated), 10/pk



MODEL: ACQUITY H-CLASS BIO QSM, ACQUITY H-CLASS QSM, ACQUITY I-CLASS BSM, ACQUITY UPLC BSM, OPEN ARCHITECTURE UPLC, nanoACQUITY UPLC BSM/ASM

11-2526
OEM 700002635

Ferrule Set, 1/16" ID, Two-Piece, 10/pk

AUTOSAMPLER

MODEL: ACQUITY, nanoACQUITY, H-CLASS, I-CLASS



MODEL: ACQUITY UPLC
SAMPLE MGR

CTS-A11151
OEM 700002644

Needle Assembly, PEEK™



MODEL: ACQUITY
UPLC SAMPLE MGR,
nanoACQUITY UPLC
SAMPLE MGR

CTS-11149
OEM 700002572

**Needle Seal O-Ring,
002 Kalrez**

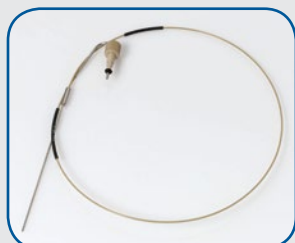

MODEL: ACQUITY UPLC
SAMPLE MGR, nanoACQUITY
UPLC SAMPLE MGR

CTS-A11381
OEM 205000362

Needle, SS, 30µL



MODEL: ACQUITY H-CLASS
SM-FTN, ACQUITY I-CLASS
SM-FTN, ACQUITY UPLC
SAMPLE MGR, nanoACQUITY
UPLC SAMPLE MGR

CTS-A11167
OEM 700002570

**100µL Sample Metering
Syringe, HP**

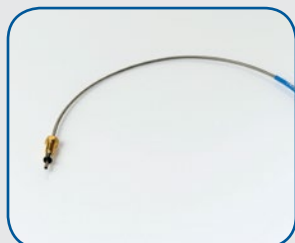

MODEL: ACQUITY UPLC
SAMPLE MGR

CTS-A11142
OEM 430001084

Tube Assy, Inject Outlet



MODEL: ACQUITY UPLC
SAMPLE MGR, nanoACQUITY
UPLC SAMPLE MGR, OPEN
ARCHITECTURE UPLC

CTS-A11147
OEM 430001326

Sample Loop, 10µL



MODEL: ACQUITY
UPLC SAMPLE MGR,
nanoACQUITY UPLC
SAMPLE MGR

CTS-11150
OEM 401000501

Filter, Air, Chassis



MODEL: ACQUITY UPLC
SAMPLE MGR, nanoACQUITY
UPLC SAMPLE MGR

11-3595
OEM 700002569

2.5mL Wash Syringe



MODEL: ACQUITY H-CLASS
SM-FTN, ACQUITY I-CLASS
SM-FTN

11-3606
OEM 401000694

Filter, Air, Side Panel



MODEL: ACQUITY H-CLASS
SM-FTN, ACQUITY I-CLASS
SM-FTN

11-2570
OEM 405011492

Needle Seat



MODEL: ACQUITY H-CLASS
SM-FTN, ACQUITY I-CLASS
SM-FTN

11-3602
OEM 430002452

Tubing, Pump Outlet, GP



MODEL: ACQUITY H-CLASS
SM-FTN, ACQUITY I-CLASS
SM-FTN

11-2591
OEM 405008854

Needle Guide

DETECTOR LAMPS

MODEL: 470, 474, 484, 486, 996, 2487, 2488, 2996



MODEL: 484, 486, 490

CTS-0335
OEM WAT080335
Window Gasket



MODEL: 484, 486, 490

CTS-0336
OEM WAT080336
Lamp Side Gasket



MODEL: 486

CTS-8068
OEM WAT080687
Quartz Lens



MODEL: 484, 486

CTS-10328
OEM WAT080244
Optics Cover Window



MODEL: 486

CTS-10699
OEM 70000356
**Deuterium Lamp,
Long Life (2000 hr)**



MODEL: 486

CTS-11065 KIT
OEM WAT052666
**486 Performance
Maintenance Kit**

- D2 Long-Life Lamp 1
- Battery 1
- Filter Foam 1
- Quartz Lens 1
- Slo-Blow Fuse 0.5A 1



MODEL: 996, 2996

CTS-10268
OEM WAT052586
Deuterium Lamp (2000 hr)



MODEL: 2487, 2488

CTS-10465
OEM WAS081142
Deuterium Lamp (2000 hr)



MODEL: 2487, 2488

CTS-A11184
OEM WAS081341
**Lamp Housing Window
Assembly**

DETECTOR LAMPS

MODEL: 470, 474



MODEL: 470

CTS-8389
**Xenon Lamp, w/o Holder
or Mirror**



MODEL: 474

CTS-10611
Xenon Lamp

DETECTOR LAMPS

AGILENT



MODEL: 1040, 1050, 1090

CTS-00127
OEM 79883-60002
**VW (79583C),
DAD (G1306A),
MWD (79854A)
(1000 hr)**



MODEL: 1100, 1200 VWD,
1220 VWD, G1314A/B

CTS-10494
OEM G1314-60100
**Long Life Deuterium Lamp
(2000 hr)**



MODEL: 8452A

CTS-00128
OEM 08452-60104
Deuterium Lamp (2000 hr)



MODEL: 1100, 1200 DAD,
G1315A/B, G1365A/B

CTS-10827
OEM 5181-1530
**Long Life Deuterium Lamp
(2000 hr)**



MODEL: 1050, 79853A

CTS-00129
OEM 79853-60002
1050 VW Lamp (1000 hr)



MODEL: 8453, 8454

CTS-10594
OEM 2140-0605
Deuterium Lamp (1000 hr)



MODEL: 1100, 1200 DAD,
G1315A/B, G1365A/B

CTS-10473
OEM 2140-0590
Deuterium Lamp (1000 hr)



MODEL: 1100, 1200, 1220,
1260, G1315A/B, G1365A/B

CTS-A11218
OEM 2140-0813
**Long Life Deuterium Lamp
(2000 hr)**

LAMPS

DETECTOR LAMPS

APPLIED BIOSYSTEMS (ABI), KRATOS



MODEL: 120, 120A, 130, 130A,
230A, 1000S, SF757, SF759,
SF759A, SF773, SF775, SF783,
SF783A, SF785A

CTS-00025
OEM N2920149

Deuterium Lamp (1000 hr)

PERKINELMER



MODEL: 200 SERIES, 785A

CTS-00025
OEM N2920149

Deuterium Lamp (1000 hr)

DIONEX



MODEL: DSA-1, VDM-1

CTS-00246

Deuterium Lamp (1000 hr)

SHIMADZU



MODEL: SPD-10,
SPD-10AV, SPD-10AVP,
SPD-20A, SPD-20AV

CTS-00135
OEM 228-34016-02

Deuterium Lamp (2000 hr)

PERKINELMER



MODEL: BIO 19, LAMBDA 2,
5, 7, 9, 10, 11, 12, 14, 15, 16, 17,
18, 19, 20, 40, 800, 900

CTS-10854

OEM Old B0160917, L6022728

Deuterium Lamp (1500 hr)

SPECTRA-PHYSICS



MODEL: 200, 201, 203,
204, 205, 206, 206PH,
CE100, CE500, CE1000,
CE2000, SP100, SP200,
SPECTRACHROM 200,
UV100, UV150, UV200,
UV1000, UV2000, UV3000

CTS-00246
OEM 9551-0023

Deuterium Lamp (1000 hr)

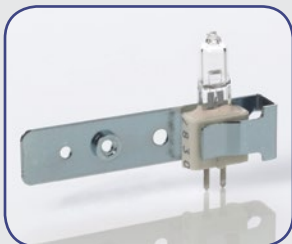

MODEL: LC-480 PDA,
LAMBDA BIO, LAMBDA 2,
10, 11, 12, 14, 15, 16, 17, 18, 19,
20, 25, 35, 40, 45, 550, 551,
552, 552A, 553, 559, 559A,
800, 900

11-3343

OEM B0114620

Tungsten Lamp

THERMO SCIENTIFIC (TSP)



MODEL: 200, 201, 203,
204, 205, 206, 206PH,
CE100, CE500, CE1000,
CE2000, SP100, SP200,
SPECTRACHROM 200,
UV100, UV150, UV200,
UV1000, UV2000, UV3000

CTS-00246
OEM 9551-0023

Deuterium Lamp (1000 hr)



MODEL: UV6000

CTS-A123
OEM 108052

**Lamp Assembly, TSP
UV6000 Detector**

DETECTOR LAMPS

WATERS



MODEL: 470
CTS-8389
Xenon Lamp, w/o Holder or Mirror



MODEL: 996, 2996
CTS-10268
OEM WAT052586
Deuterium Lamp (2000 hr)



MODEL: 474
CTS-10611
Xenon Lamp



MODEL: 2487, 2488
CTS-10465
OEM WAS081142
Deuterium Lamp (2000 hr)



MODEL: 486
CTS-10699
OEM 700000356
Deuterium Lamp, Long Life (2000 hr)

TOOLS

TOOLS



44-1773
7/16" x 7/16" Open End Wrench
(for 1/16" compression nuts)



44-1774
9/16" x 9/16" Open End Wrench
(for 1/8" compression nuts)



44-1777
3/4" x 3/4" Open End Wrench
(for 1/4" compression nuts)



CTS-00089
5/16" x 3/8" Open End Wrench,



CTS-00090
1/4" x 5/16" Open End Hex Wrench



CTS-00091
6" Adjustable Wrench



CTS-1059
Microprobe - Straight



CTS-1060
Microprobe - Arched



CTS-1042
OEM WAT011042
Plunger Insertion Tool



CTS-TT-1001
Terry Tool Tubing Cutter



CTS-TT-1003
Replacement Cutting Wheels, 3/pk



11-2574
Tubing Cutter for Polymeric
1/16" to 1/8" OD Tubing



11-2585
Tubing Cutter for Polymeric
3/16" to 5/16" OD Tubing



44-1781
Tubing Bender

FILTERS, FITTINGS & TUBING

MOBILE PHASE SOLVENT FILTERS



CTS-A11259
Solvent Filter 10µm SS with 1/8" Stem



CTS-5531
Solvent Filter 10µm SS with 1/8" Stem



11-1414
Solvent Filter 10µm SS with 1/16" Stem



11-1418
Solvent Filter 10µm SS with 1/4-28 Nut/Ferrule for 1/8" OD Tubing



11-1419
Solvent Filter 20µm SS with 5/16-24 Nut/Ferrule for 3/16" or 4mm OD Tubing



11-1420
Solvent Filter 10µm SS with 1/4-28 Nut/Ferrule for 1/16" OD Tubing



11-1421
Solvent Filter 10µm SS with 1/4-28 Nut/Ferrule for 2mm OD Tubing



11-1422
Solvent Filter 10µm SS with 1/4-28 Nut/Ferrule for 3mm OD Tubing



11-1888
Adapter ETFE with 1/4-28 Female Port for use with CTS-10843 (adapts glass filter for use with Mobile Phase tubing 1mm to 1/8" OD)





CTS-10843
Glass Solvent Filter

FILTERS, FITTINGS & TUBING

HIGH PRESSURE FITTINGS

Stainless Steel Nut/Ferrules

	Part No.	Description
	11-1237	Nut 10-32 Stainless Steel Male for 1/16" OD Tubing, 10/pk
	11-1239	Ferrule Stainless Steel for 1/16" OD Tubing, 10/pk
	CTS-11016 KIT	Swagelok® Style Compression Fitting Kit, 10/pk <ul style="list-style-type: none"> • Nut 10 • Front Ferrule 10 • Back Ferrule 10



Plug 10-32 PEEK™

	Part No.	Description
	CTS-1820	Grip-tight PEEK™ 10-32 HPLC Column Plug

Fingertight One-Piece Nut/Ferrules

	Part No.	Description
	11-1240	Fingertight One-Piece 10-32 PEEK™ Male Nut/Ferrule for 1/16" Tubing, 10/pk



Fingertight Two-Piece Nut/SealTight Ferrules

	Part No.	Description
	11-1257	Fitting 10-32 Fingertight PEEK™ Short Male Nut/SealTight PEEK™ Ferrule for 1/16" OD Tubing, 10/pk
	11-1259	Fitting 10-32 Fingertight PEEK™ Long Male Nut/SealTight PEEK™ Ferrule for 1/16" OD Tubing, 10/pk
	11-1269	Ferrule SealTight PEEK™ for 1/16" OD Tubing, 10/pk

Fingertight Two-Piece Nut/Ferrules

	Part No.	Description
	11-1209	Fitting 10-32 Fingertight Red Delrin Single Wing-Nut Male/PEEK™ Ferrule for 1/16" OD Tubing, 10/pk
	11-1213	Fitting 10-32 Fingertight PEEK™ Double Wing-Nut Male Nut/PEEK™ Ferrule for 1/16" OD Tubing, 10/pk
	11-1217	Fitting 10-32 Fingertight PEEK™ Long Male Nut/PEEK™ Ferrule for 1/16" OD Tubing, 10/pk
	11-1221	Fitting 10-32 Fingertight PEEK™ Short Male Nut/PEEK™ Ferrule for 1/16" OD Tubing, 10/pk
	11-1255	Ferrule PEEK™ for 1/16" OD Tubing, 10/pk





Fingertight RheFlex Two-Piece Nut/Split Ferrules

	Part No.	Description
	11-1271	Fitting 10-32 RheFlex PEEK™ Male Nut/Split Ferrule for 1/16" OD Tubing, 10/pk
	11-1274	Ferrule Split PEEK™ for 1/16" OD Tubing, 10/pk

FILTERS, FITTINGS & TUBING

TUBING

Stainless Steel Tubing

	Part No.	Description
	11-2612	Tubing Stainless Steel 1/16" OD x 250µm (0.010") ID x 10ft
	11-2610	Tubing Stainless Steel 1/16" OD x 0.50mm (0.020") ID x 10ft
	11-1201	Tubing Stainless Steel 1/16" OD x 0.75mm (0.030") ID x 10ft
	11-2611	Tubing Stainless Steel 1/16" OD x 1mm (0.040") ID x 10ft

PEEK™ Tubing (Red) – 0.005" ID x 1/16" OD

	Part No.	Description
	11-1151	Tubing PEEK™ Red 1/16" OD x 0.005" ID x 5ft
	11-1152	Tubing PEEK™ Red 1/16" OD x 0.005" ID x 10ft
	11-1153	Tubing PEEK™ Red 1/16" OD x 0.005" ID x 20ft
	11-1154	Tubing PEEK™ Red 1/16" OD x 0.005" ID x 50ft
	11-1155	Tubing PEEK™ Red 1/16" OD x 0.005" ID x 100ft

PEEK™ Tubing (Yellow) – 0.007" ID x 1/16" OD

	Part No.	Description
	11-1156	Tubing PEEK™ Yellow 1/16" OD x 0.007" ID x 5ft
	11-1157	Tubing PEEK™ Yellow 1/16" OD x 0.007" ID x 10ft
	11-1158	Tubing PEEK™ Yellow 1/16" OD x 0.007" ID x 20ft
	11-1159	Tubing PEEK™ Yellow 1/16" OD x 0.007" ID x 50ft
	11-1160	Tubing PEEK™ Yellow 1/16" OD x 0.007" ID x 100ft

PEEK™ Tubing (Blue) – 0.010" ID x 1/16" OD

	Part No.	Description
	11-1136	Tubing PEEK™ Blue 1/16" OD x 0.010" ID x 5ft
	11-1137	Tubing PEEK™ Blue 1/16" OD x 0.010" ID x 10ft
	11-1138	Tubing PEEK™ Blue 1/16" OD x 0.010" ID x 20ft
	11-1139	Tubing PEEK™ Blue 1/16" OD x 0.010" ID x 50ft
	11-1140	Tubing PEEK™ Blue 1/16" OD x 0.010" ID x 100ft





FILTERS, FITTINGS & TUBING

TUBING

PEEK™ Tubing (Orange) – 0.020" ID x 1/16" OD

	Part No.	Description
	11-1141	Tubing PEEK™ Orange 1/16" OD x 0.020" ID x 5ft
	11-1142	Tubing PEEK™ Orange 1/16" OD x 0.020" ID x 10ft
	11-1143	Tubing PEEK™ Orange 1/16" OD x 0.020" ID x 20ft
	11-1144	Tubing PEEK™ Orange 1/16" OD x 0.020" ID x 50ft
	11-1145	Tubing PEEK™ Orange 1/16" OD x 0.020" ID x 100ft

PEEK™ Tubing (Green) – 0.030" ID x 1/16" OD

	Part No.	Description
	11-1146	Tubing PEEK™ Green 1/16" OD x 0.030" ID x 5ft
	11-1147	Tubing PEEK™ Green 1/16" OD x 0.030" ID x 10ft
	11-1148	Tubing PEEK™ Green 1/16" OD x 0.030" ID x 20ft
	11-1149	Tubing PEEK™ Green 1/16" OD x 0.030" ID x 50ft
	11-1150	Tubing PEEK™ Green 1/16" OD x 0.030" ID x 100ft

PEEK™ Tubing (Natural) – 0.040" ID x 1/16" OD

	Part No.	Description
	11-1162	Tubing PEEK™ Natural 1/16" OD x 0.040" ID x 5ft
	11-1163	Tubing PEEK™ Natural 1/16" OD x 0.040" ID x 10ft
	11-1164	Tubing PEEK™ Natural 1/16" OD x 0.040" ID x 20ft
	11-1165	Tubing PEEK™ Natural 1/16" OD x 0.040" ID x 50ft
	11-1166	Tubing PEEK™ Natural 1/16" OD x 0.040" ID x 100ft

PUMP TROUBLESHOOTING PROCEDURES

You can troubleshoot most Waters M6000, 510, 590, 600, and 610 pumping problems in a short time by observing the pressure meter on your pump. The following procedures will show you how.

RAMP TEST

This is the first test to try, as it involves the least amount of work and disassembly, and it will find most pumping problems.

1. Disconnect the outlet of the pump from the rest of your HPLC system.
2. Connect a short piece of tubing to the pump outlet, and put the other end of this tube into a beaker.
3. Prime the pump thoroughly with methanol. Make sure you have drawn enough methanol through the solvent inlet line to ensure the pump is pumping methanol.
4. Remove the tubing at the pump outlet and install a plug fitting to stop flow.
5. Set the pressure limit for 4000-5000 psi.
6. Set the flow rate for 0.3-1.0 ml/min and observe the psi meter and the indicator rods. With a properly-operating pump, you will see a smooth increase in pressure until the pressure limit is reached.

Below are two examples of the most common symptoms of Ramp Test failure and how to resolve them. The examples use the left and right side to describe the symptoms: interchange the left and right in the text if needed to match your symptoms.

SYMPTOM #1

While watching the left indicator rod coming out, the pressure increases. When the right indicator rod comes out, the pressure stops increasing and stays about the same. When the left indicator rod again begins coming out, the pressure again begins increasing.

ANALYSIS

The right inlet check valve is not working. This symptom is fairly easy to understand. The inlet check valve is either stuck open, and the mobile phase is sloshing back and forth as the plunger goes in and out, or it is stuck shut, never allowing mobile phase into the pump head.

Possible Problem	Solution
Check valve dirty	Clean and rebuild
Seat worn out	Clean and rebuild

SYMPTOM #2

While watching the left indicator rod coming out, the pressure increases. When the right indicator rod comes out, the pressure drops almost back to zero. When the left indicator rod again begins coming out, the pressure again increases.

ANALYSIS

The left outlet check valve is leaking back. This symptom is more difficult to understand, until you think about where the mobile phase is going. When the left plunger comes out, the pressure increases. When the right plunger comes out, it pumps mobile phase out, into the reference valve or tee fitting, and over to the left side. The left outlet check valve is leaking backwards, allowing what the right side is pumping to enter and fill the left side as the left plunger is going in.

Possible Problem	Solution
Check valve dirty	Clean in ultrasonic cleaner; flush thoroughly with methanol in priming syringe; disassemble and rebuild check valve
Air bubble trapped in check valve	Reprime with methanol

OTHER SYMPTOMS

If your symptoms differ from these, you may have multiple problems and should use the Modified Ramp Test. This test is also useful if you want to verify your troubleshooting from the above steps or you are unsure of your diagnosis.

MODIFIED RAMP TEST

(Perform steps 1 - 5 from the standard Ramp Test.)

1. Disconnect the outlet of the pump from the rest of your HPLC system.
2. Connect a short piece of tubing to the pump outlet and put the other end of this tube into a beaker.
3. Prime the pump thoroughly with methanol. Make sure you have drawn enough methanol through the solvent inlet line to ensure the pump is pumping methanol.
4. Remove the tubing at the pump outlet and install a plug fitting, to stop flow.
5. Set the pressure limit for 4000-5000 psi.
6. Disconnect the tube between the outlet check valve and the reference valve or tee fitting, at the reference valve or tee, on the side of the pump not being tested (if you are testing the left side, disconnect the right side).
7. Put a plug fitting into the reference valve or tee where you removed the tube. You may want to put a towel under the open end of the disconnected tube; it will drip a little during the following steps. Do not cap the dripping tube.
8. Set the flow to 1 ml/min, and observe the psi meter and the indicator rod on the side being tested.

SYMPTOM #1

The pressure increases steadily while the plunger is coming out and holds pressure while the plunger is retracting. Analysis: This pump head is pumping okay.

SYMPTOM #2

The pressure never increases above 0 psi. Analysis: The inlet check valve is not working. Reprime this pump head and try again. If this fails, see Symptom #1 of the Ramp Test to repair.

SYMPTOM #3

The pressure increases steadily while the plunger is coming out, but drops abruptly while the plunger is retracting. Analysis: The outlet check valve is leaking back. See symptom #2 of the Ramp Test to repair.

SYMPTOM #4

The pressure increases steadily during the first plunger out stroke, but increases less during the next out strokes; the pressure holds while the plunger is retracting solution. The plunger seal is beginning to leak, or the inlet check valve is leaking back slightly. To repair, look at the weep hole at the bottom of the support bushing, or between the pump head and the support bushing, and see if the mobile phase has been leaking past the plunger seal. If so, slightly tighten the two allen head screws holding the pump head and retest. If the pump head is tight against the support bushing, it is time to replace the plunger seal. If the inlet check valve is leaking back, see symptom #1 of the Ramp Test to repair.

OTHER SYMPTOMS

If you need any further assistance, please feel free to call 952.895.8292 or toll-free at 800.682.3295 during the hours of 8 a.m. to 5 p.m. CST. Thanks for calling!